

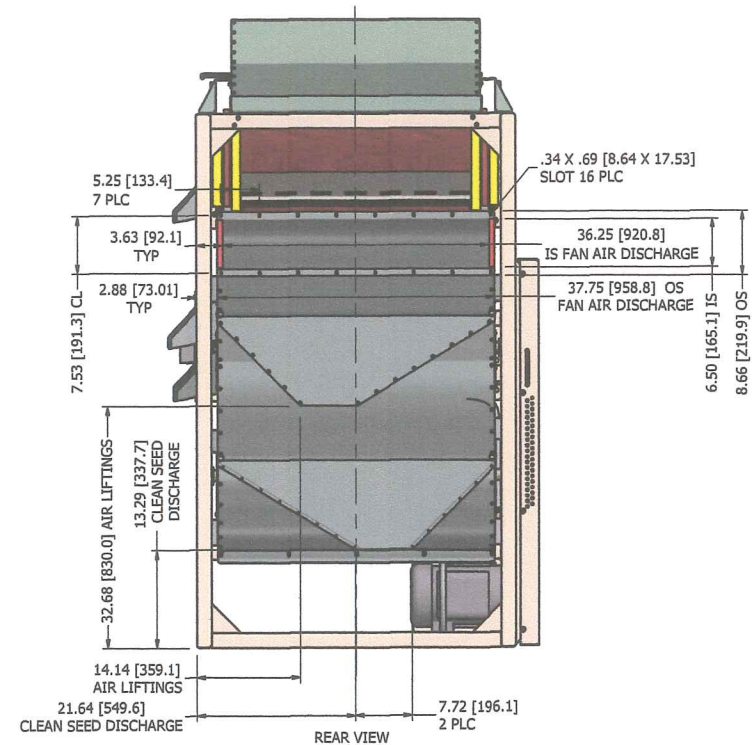

REV	ECN	DESCRIPTION	DATE	APPROVED
-	F010001	RELEASE	2/13/01	DJ
A	F030068	RELEASE PRINT 2 OF 2, INSTALL W/ COTTONWOOD HOPPER	8/21/03	DJ
B	F180059	REDRAWN IN INVENTOR, SHEETS 4, 5, 6, & 7 ADDED	7/31/2018	samelching

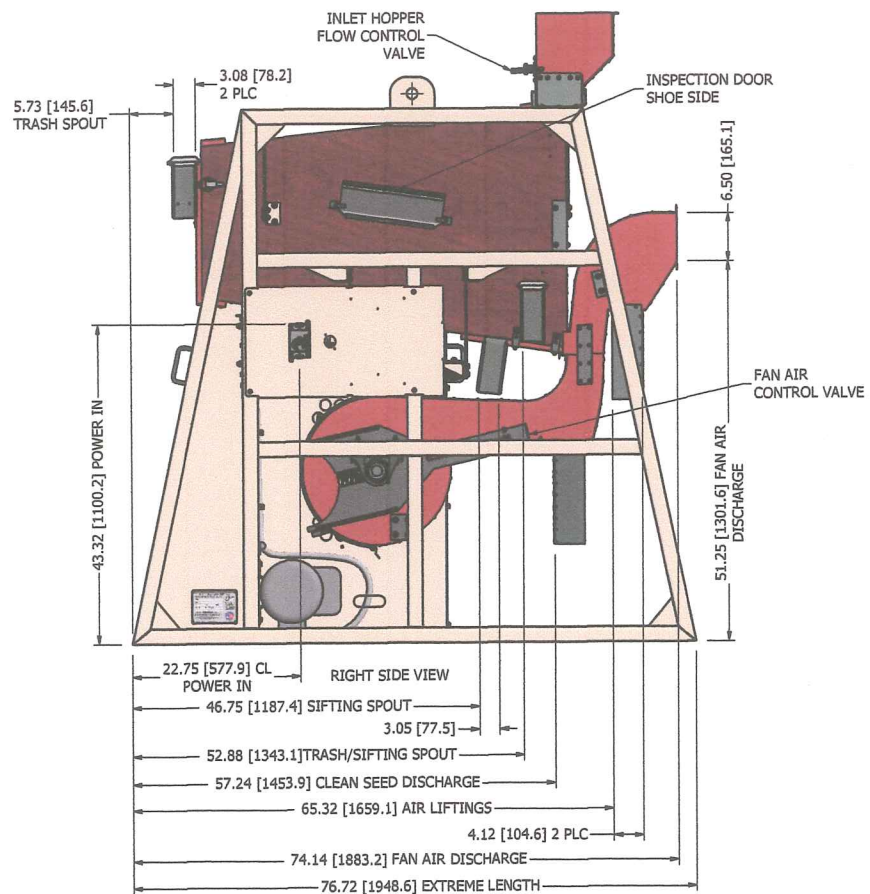
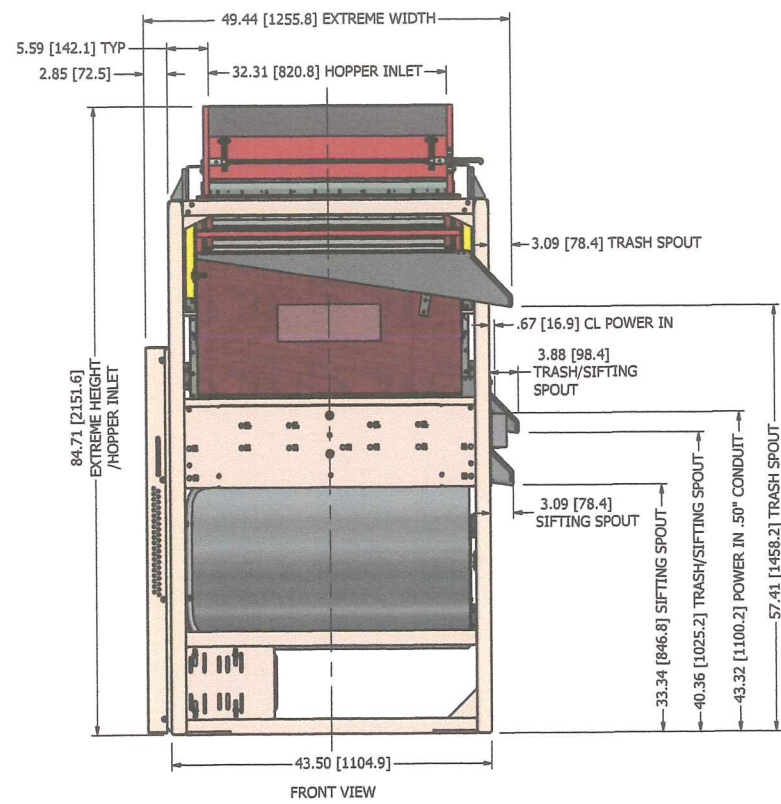
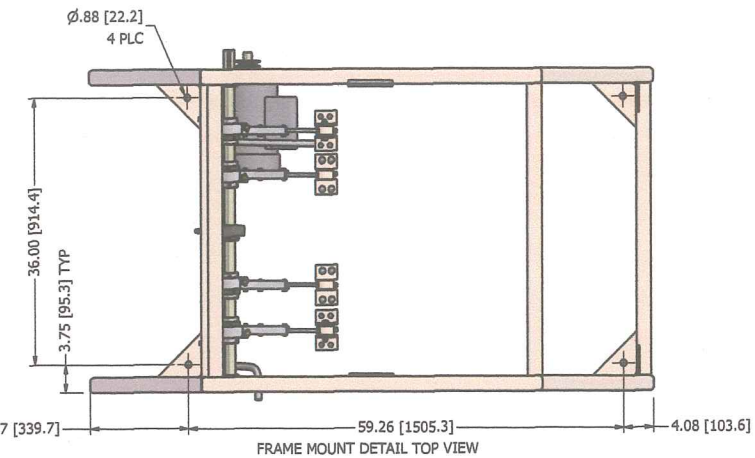
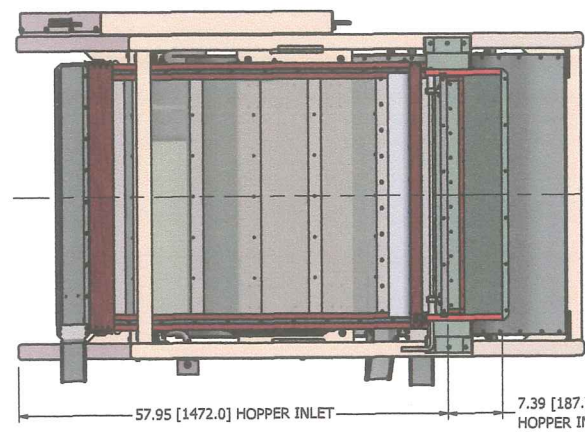
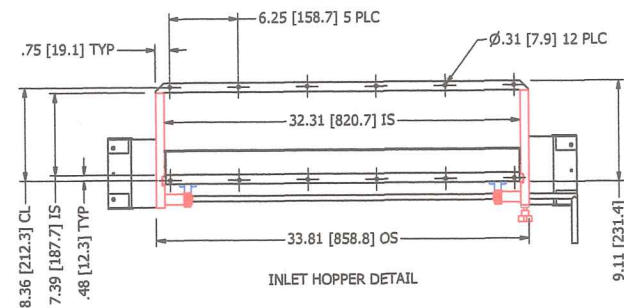

- NOTES:
- DO NOT SCALE FROM DRAWING.
  - SHIPPING WEIGHT: 1874 LBS (850 kg) WITH SHIPPING SKID.
  - FAN AIR = 2950 CFM (83.5 CMM).
  - ALTERNATIVE UNITS [X.XX] IN MILLIMETERS.
  - .50" [12.70 MM] SHOE TOTAL THROW.
  - SEE PRINT 2 OF 7 FOR ECLIPSE 334 WITH COTTONSEED INLET HOPPER.
  - SEE PRINT 3 OF 7 FOR ECLIPSE 334 WITH 44" CYCLONE.
  - SEE PRINT 4 OF 7 FOR ECLIPSE 334 WITH 10" TRANSITION.
  - SEE PRINT 5 OF 7 FOR ECLIPSE 334 WITH 4" TRANSITION.
  - SEE PRINT 6 OF 7 FOR ECLIPSE 334 WITH 24" STAND.
  - SEE PRINT 7 OF 7 FOR ECLIPSE 334 WITH 9 BUSHSEL SURGE HOPPER.
  - AIR DUCTING BETWEEN CLEANER, BLOWER & CYCLONE TO BE SUPPLIED AS REQUIRED.

**STANDARD INSTALLATION**

		DIVISION OF <b>A.T. FERRELL COMPANY</b> 1440 S ADAMS ST BLUFFTON, INDIANA 46714 - USA PH: 280-824-3400 FAX: 280-824-5463		This drawing is the property of the A.T. Ferrell Company, Inc and must be returned immediately upon request. No part of this drawing may be reproduced, stored in a retrieval system or transmitted in any form or by any means, without prior written consent of the A.T. Ferrell Company, Inc.	
TOLERANCES EXCEPT AS NOTED DECIMAL: ± .005 XX ± .005 XXX ± .005 XXXX ± .001		TITLE: <b>INSTALLATION, RH &amp; CTR DISCHARGE, ECLIPSE 334</b>		DRAWN BY: samelching	
FINISH: NONE		SCALE: 1:8		DRAWN DATE: 7/18/2018	
CAD NO MANUAL CHANGES		SHEET: 1 OF 7		APPROVED BY: DMJ	
SIZE: D		PART NUMBER: F60000100-I		REV: B	