

REVISION HISTORY				
REV	ECN	DESCRIPTION	DATE	APPROVED
A	F100036	REDRAWN IN INVENTOR, UPDATED ASSY	2/22/2010	SH

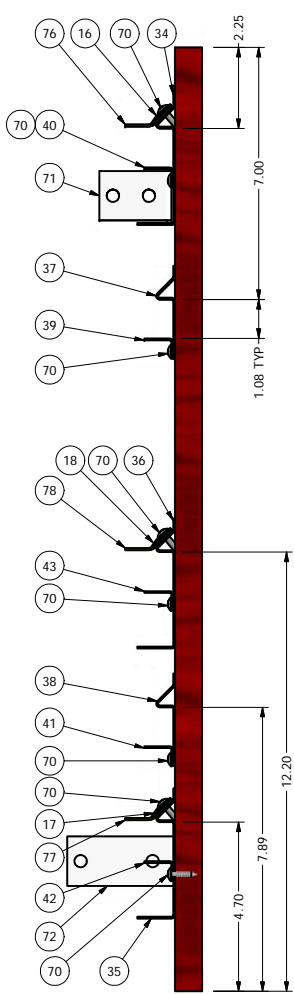
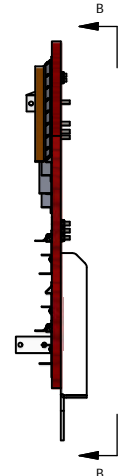
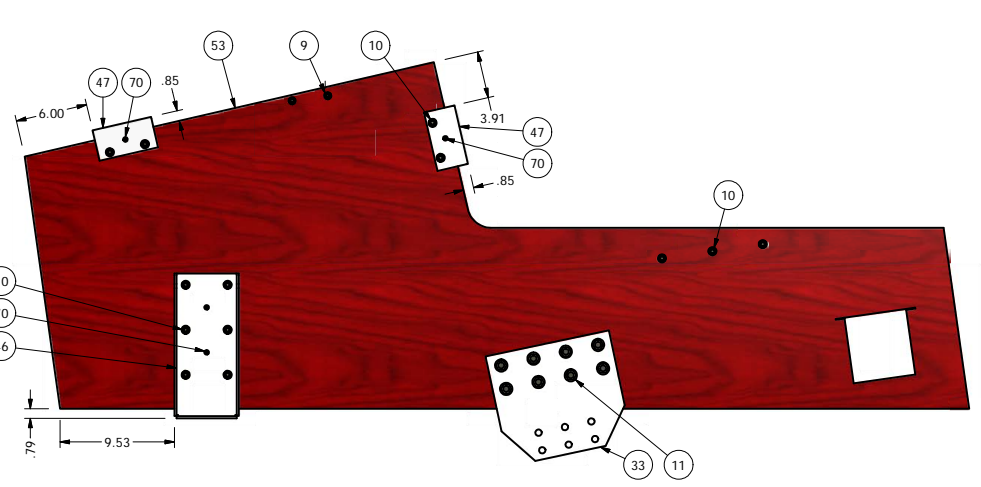
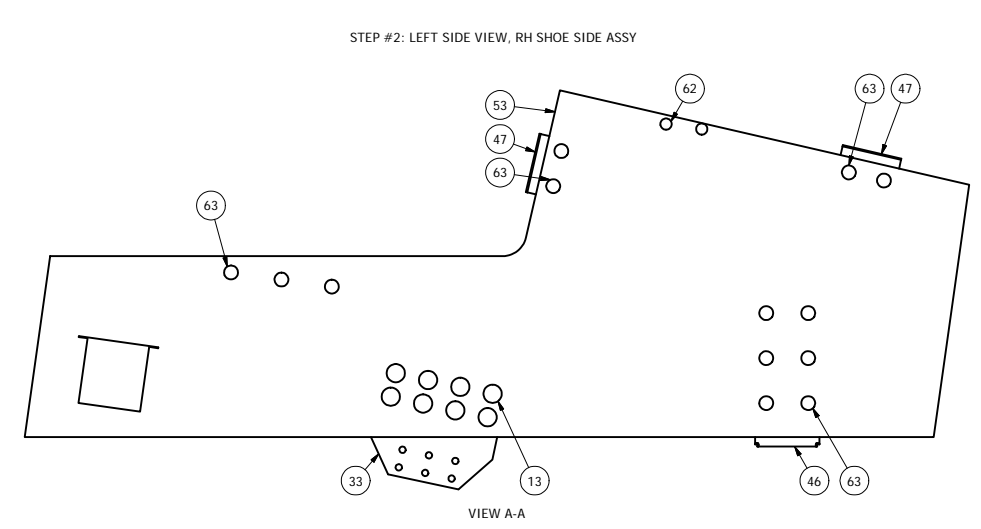
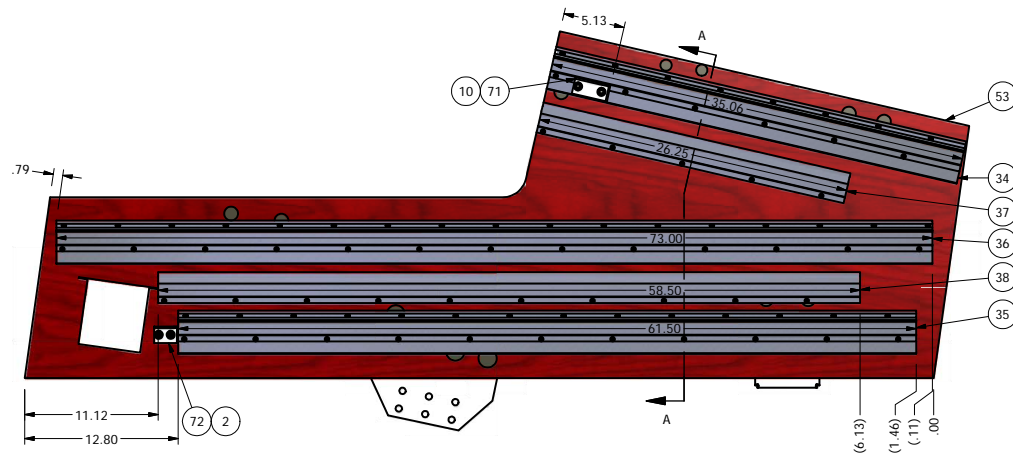
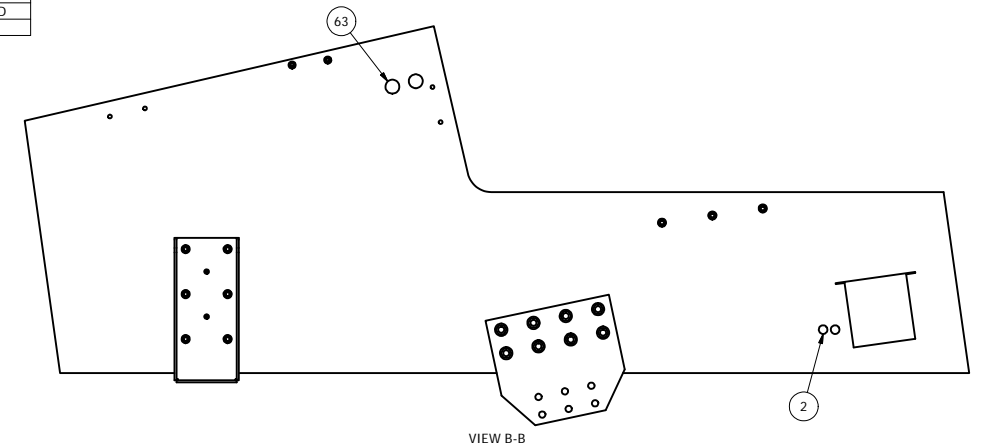

SECTION A-A
SCALE 3/8

84	SALES ORDER	5	SCREEN ASSY, 26" W/LIP
83	F98600005	2	STRIKE, SCD20650-9XZE
82	F98600005	2	LATCH, SCD 20649 SS
81	F98200006	4	HINGE, TEE 3.00"
80	F92053390	2	SCREEN BLANK ASSY, 9X54" W/LIP
79	F91152006	1	BELTING, 1-PLY .06X2.50X51.00"
78	F91152004	2	BELTING, 3-PLY FSXFS 1.50 X 75.00"
77	F91152004	2	BELTING, 3-PLY FSXFS 1.50 X 63.50"
76	F91152004	2	BELTING, 3-PLY FSXFS 1.50 X 37.06"
75	F91152004	1	BELTING, 1-PLY .06X1.50X51.00"
74	F91151004	1	BELTING, 1-PLY .06 X 4.00 X 51.00"
73	F90008270	5	BALL TRAY WLDMT, 26.25 X 54.00" NG
72	F90005474	2	SCREEN STOP WLDMT, RH NG
71	F90005473	2	SCREEN STOP WLDMT, LH NG
70	F83453402	469	SMS, PHP PAN HD #8 X 3/4"
69	F83440301	38	SMS, FLAT CROSS HEAD #10 X 1.50"
68	F83440135	16	SCW, SMS PAN HD #10 X 1.75"
67	F83200011	23	RIVET, POP SDS64 .188X.125-.250
66	F82631032	12	NUT, KEPS 10-32
65	F82400002	28	NAIL, 14 GA X 3/4" THRD, 7/32" HD T304SS
64	F82071401	2	STUD, DOWEL 1/4-20 X 2.50"
63	F82025603	38	BOLT, ELEV 5/16-18 X 1.50"
62	F82021407	4	BOLT, ELEV 1/4-20 X 1.25"
61	F80026101	240	BALL, RUBBER 1.375 DIA BLACK
60	F62241426	1	BLANK, SCREEN 4.00 X 54.00" W/LIP
59	F62241425	1	SCREEN BLANK ASSY, 5X54" W/LIP
58	F61261328	1	DEFLECTOR, SHOE 4.00"X45
57	F61261325	1	SHOE BOTTOM METAL II, PRELUDE
56	F61261324	1	DEFLECTOR, FRONT, PRELUDE SHOE
55	F61261322	1	SHOE BOTTOM METAL I, PRELUDE
54	F61261321	1	DOOR, PRELUDE SHOE
53	F61261320	2	SIDE, SHOE PRELUDE
52	F61001258	3	SPOUT, DISCHARGE 5 DEG, CONQUEST
51	F61001251	1	PLUG, SPOUT, SHOE SIDE, CONQUEST
50	F61001248	2	BRACKET, SCALP SPOUT, CONQUEST
49	F61001216	1	SPLITTER WLDMT, 50/50 HI-CAP, 9.00" X #8
48	F61001214	1	DEFLECTOR, SPOUT, CONQUEST
47	F61001212	8	BRACKET, CROSS BOARD 5.00"
46	F61001210	2	HANGER SUPPORT, CONQUEST
45	F61001209	2	BOARD, CROSS 7 DEG 5.00 X 55.75"
44	F61001208	5	BOARD, CROSS 5.00 X 55.75"
43	F61001206	2	SCREENWAY RAIL III, 73.00"
42	F61001206	2	SCREENWAY RAIL III, 61.50"
41	F61001206	2	SCREENWAY RAIL III, 58.50"
40	F61001206	2	SCREENWAY RAIL III, 35.06"
39	F61001206	2	SCREENWAY RAIL III, 26.25"
38	F61001205	2	SCREENWAY RAIL II, 58.50"
37	F61001205	2	SCREENWAY RAIL II, 26.25"
36	F61001204	2	SCREENWAY RAIL I, 73.00"
35	F61001204	2	SCREENWAY RAIL I, 61.50"
34	F61001204	2	SCREENWAY RAIL I, 35.06"
33	F61001203	2	PLATE, PITMAN, CONQUEST
32	F61001200	1	PITMAN WLDMT, 55.75"
31	F61001116	1	DIVERTER ASSY, 8.00X54.00", BTM SHOE, CNQST
30	F61001112	2	END IRON, BOTTOM SHOE, CONQUEST
29	F61001111	1	COVER, SPOUT HOLE, BTM SHOE, CONQUEST
28	F61001110	1	BACK MTL, BTM SHOE, CONQUEST 1360
27	F61001109	1	MTL III, BTM, BTM SHOE, CONQUEST 1360
26	F61001106	2	SPACER, HANGER, BTM SHOE, CONQUEST
25	F61001104	1	BOARD, BACK, BOTTOM SHOE, CONQUEST 1360
24	F61001103	2	BOARD, CROSS 12.81 X 55.75"
23	F61001102	1	BOARD, CROSS INTERNAL 2.50 X 54.25"
22	F61001008	2	SUPPORT, SPOUT, CONQUEST
21	F10808000	3	BLANK ASSY, SCREEN W/LIP 26.25 X 54.00"
20	F10516200	1	SCREEN BLANK, 3X54" W/LIP
19	F03805600	3	RUBBER HOLD-DOWN STRIP, 51.00"
18	F03805600	2	RUBBER HOLD-DOWN STRIP 73.00"
17	F03805600	2	RUBBER HOLD-DOWN STRIP 61.50"
16	F03805600	2	RUBBER HOLD-DOWN STRIP 35.06"
15	F03500800	16	SCREEN HOOK ASSY, STANDARD
14	F03401702	1	APRON ASSY, 1.25 X 55.75"
13	80016019	16	BOLT, ELEV 1/2-13 X 2.00"
12	70010521	30	SCW, DECK FLT HD #6 X 2.00"
11	66785200	16	NUT, 1/2-13 HEX SERRATED
10	66783800	52	NUT, HEX SERR LOCK 5/16-18
9	66783300	26	NUT, HEX SERR LOCK 1/4-20
8	66445200	12	WASHER, LOCK HELICAL 1/2"
7	66444400	8	WASHER, LOCK HELICAL 3/8"
6	62585226	12	HHCS, 1/2-13 X 1.25"
5	62584426	8	HHCS, 3/8-16 X 1.25"
4	62583837	10	HHCS, 5/16-18 X 2.50"
3	62282712	12	SCW, MACH 10-32 X 1/2" PAN CROSS HEAD
2	60283828	14	BOLT, CARR 5/16-18 X 1.50"
1	60283326	20	BOLT, CARR 1/4-20 X 1.25"

This drawing is the property of the A.T. Ferrell Company, Inc and must be returned immediately upon request. No part of this drawing may be reproduced, stored in a retrieval system or transmitted in any form or by any means, without prior written consent of the A.T. Ferrell Company, Inc	CAD NO MANUAL CHANGES	DIVISION OF A. T. FERRELL COMPANY BLUFFTON, INDIANA - USA		
	TOLERANCES EXCEPT AS NOTED DECIMAL: .005 XX ± .030 FRACTIONAL: 1/32 ANGULAR: ± 1/2°	FINISH: NONE SCALE: 1:8 DRAWN BY: SAH APPROVED BY: DJ	TITLE: ASSY, PRELUDE SHOE DATE: 2/15/2010 SIZE: D PART NUMBER: F61261311 SHEET: 1 of 8	
	ITEM PART NUMBER QTY DESCRIPTION			

NOTES:
1. DO NOT SCALE FROM DRAWING.

STEP #1: RIGHT SIDE VIEW, RH SHOE ASSY
 F61001212 REF ONLY FOR LOCATING F82025603

F61261311

B

A

A

REVISION HISTORY				
REV	ECN	DESCRIPTION	DATE	APPROVED
A	F100036	REDRAWN IN INVENTOR, UPDATED ASSY	2/22/2010	SH

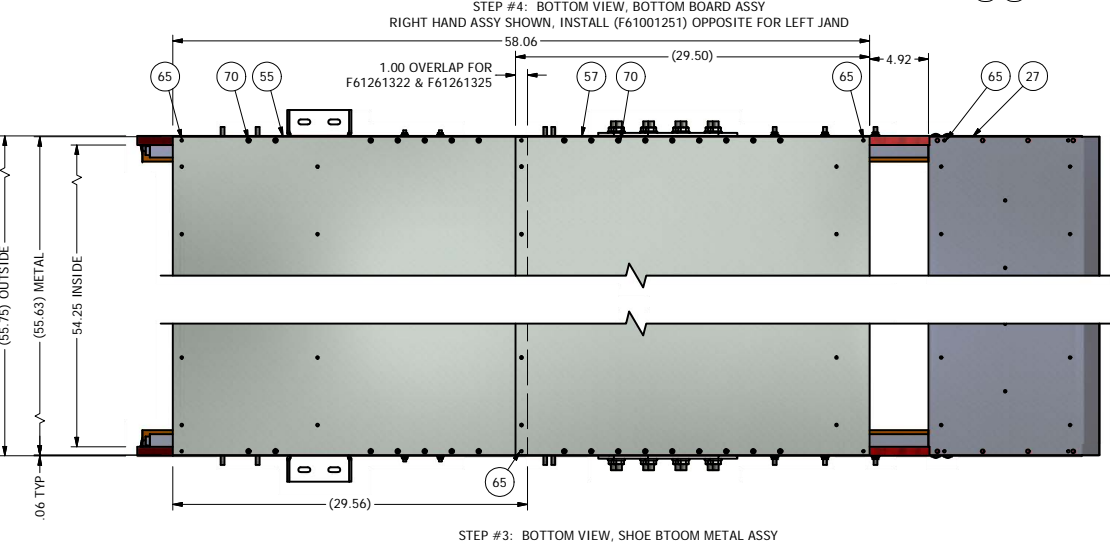
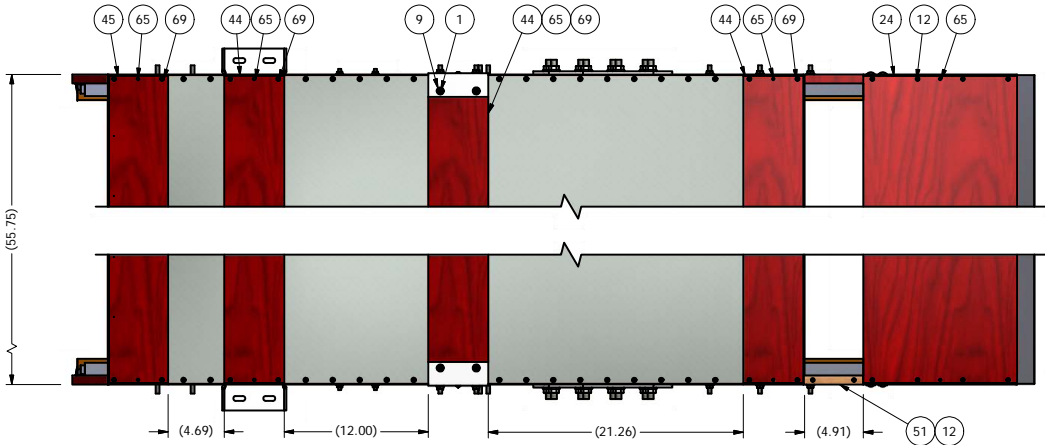
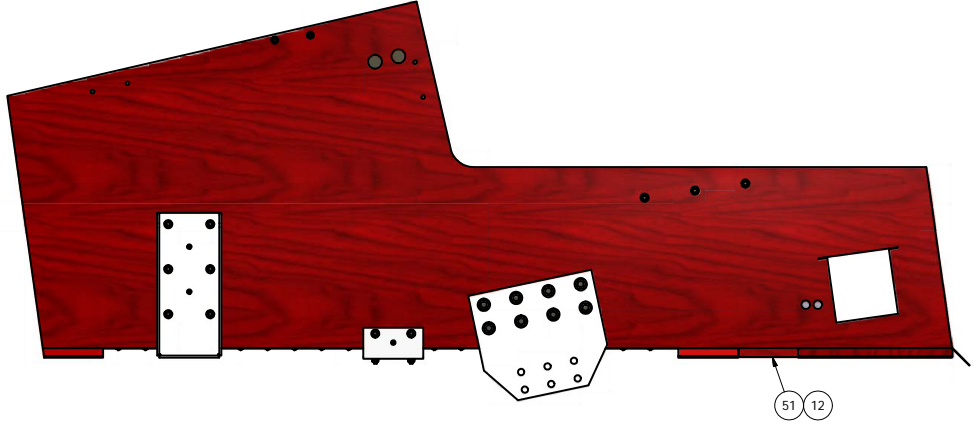
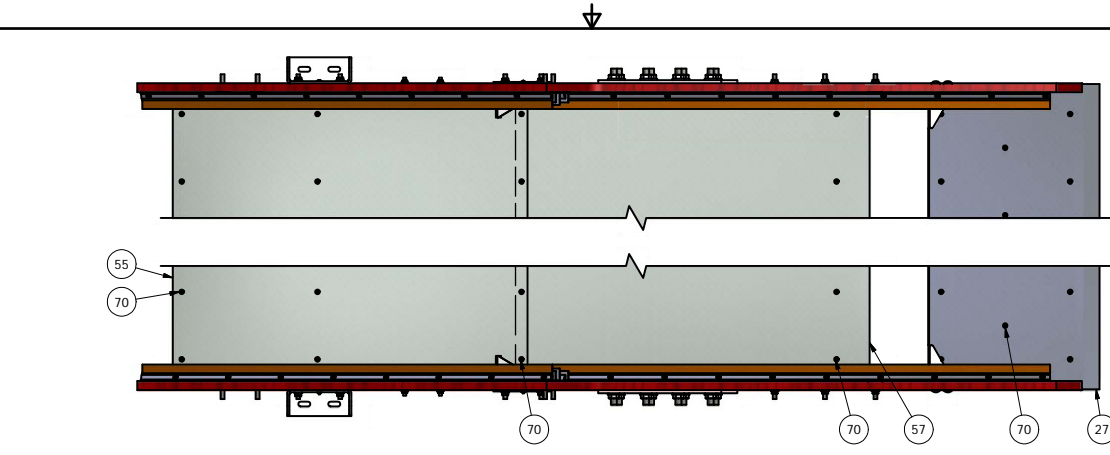

84	SALES ORDER	5	SCREEN ASSY, 26" W/LIP
83	F98600005	2	STRIKE, SCD20650-9XZE
82	F98600005	2	LATCH, SCD 20649 SS
81	F98200006	4	HINGE, TEE 3.00"
80	F92053390	2	SCREEN BLANK ASSY, 9X54" W/LIP
79	F91152006	1	BELTING, 1-PLY .06X2.50X51.00"
78	F91152004	2	BELTING, 3-PLY FSXFS 1.50 X 75.00"
77	F91152004	2	BELTING, 3-PLY FSXFS 1.50 X 63.50"
76	F91152004	2	BELTING, 3-PLY FSXFS 1.50 X 37.06"
75	F91152004	1	BELTING, 1-PLY .06X1.50X51.00"
74	F91151004	1	BELTING, 1-PLY .06 X 4.00 X 51.00"
73	F90008270	5	BALL TRAY WLDMT, 26.25 X 54.00" NG
72	F90005474	2	SCREEN STOP WLDMT, RH NG
71	F90005473	2	SCREEN STOP WLDMT, LH NG
70	F83453402	469	SMS, PHP PAN HD #8 X 3/4"
69	F83440301	38	SMS, FLAT CROSS HEAD #10 X 1.50"
68	F83440135	16	SCW, SMS PAN HD #10 X 1.75"
67	F83200011	23	RIVET, POP SDS64 .188X.125-.250
66	F82631032	12	NUT, KEPS 10-32
65	F82400002	28	NAIL, 14 GA X 3/4" THRD, 7/32" HD T304SS
64	F82071401	2	STUD, DOWEL 1/4-20 X 2.50"
63	F82025603	38	BOLT, ELEV 5/16-18 X 1.50"
62	F82021407	4	BOLT, ELEV 1/4-20 X 1.25"
61	F80026101	240	BALL, RUBBER 1.375 DIA BLACK
60	F62241426	1	BLANK, SCREEN 4.00 X 54.00" W/LIP
59	F62241425	1	SCREEN BLANK ASSY, 5X54" W/LIP
58	F61261328	1	DEFLECTOR, SHOE 4.00"X45
57	F61261325	1	SHOE BOTTOM METAL II, PRELUDE
56	F61261324	1	DEFLECTOR, FRONT, PRELUDE SHOE
55	F61261322	1	SHOE BOTTOM METAL I, PRELUDE
54	F61261321	1	DOOR, PRELUDE SHOE
53	F61261320	2	SIDE, SHOE PRELUDE
52	F61001258	3	SPOUT, DISCHARGE 5 DEG, CONQUEST
51	F61001251	1	PLUG, SPOUT, SHOE SIDE, CONQUEST
50	F61001248	2	BRACKET, SCALP SPOUT, CONQUEST
49	F61001216	1	SPLITTER WLDMT, 50/50 HI-CAP, 9.00" X #8
48	F61001214	1	DEFLECTOR, SPOUT, CONQUEST
47	F61001212	8	BRACKET, CROSS BOARD 5.00"
46	F61001210	2	HANGER SUPPORT, CONQUEST
45	F61001209	2	BOARD, CROSS 7 DEG 5.00 X 55.75"
44	F61001208	5	BOARD, CROSS 5.00 X 55.75"
43	F61001206	2	SCREENWAY RAIL III, 73.00"
42	F61001206	2	SCREENWAY RAIL III, 61.50"
41	F61001206	2	SCREENWAY RAIL III, 58.50"
40	F61001206	2	SCREENWAY RAIL III, 35.06"
39	F61001206	2	SCREENWAY RAIL III, 26.25"
38	F61001205	2	SCREENWAY RAIL II, 58.50"
37	F61001205	2	SCREENWAY RAIL II, 26.25"
36	F61001204	2	SCREENWAY RAIL I, 73.00"
35	F61001204	2	SCREENWAY RAIL I, 61.50"
34	F61001204	2	SCREENWAY RAIL I, 35.06"
33	F61001203	2	PLATE, PITMAN, CONQUEST
32	F61001200	1	PITMAN WLDMT, 55.75"
31	F61001116	1	DIVERTER ASSY, 8.00X54.00", BTM SHOE, CNQST
30	F61001112	2	END IRON, BOTTOM SHOE, CONQUEST
29	F61001111	1	COVER, SPOUT HOLE, BTM SHOE, CONQUEST
28	F61001110	1	BACK MTL, BTM SHOE, CONQUEST 1360
27	F61001109	1	MTL III, BTM, BTM SHOE, CONQUEST 1360
26	F61001106	2	SPACER, HANGER, BTM SHOE, CONQUEST
25	F61001104	1	BOARD, BACK, BOTTOM SHOE, CONQUEST 1360
24	F61001103	2	BOARD, CROSS 12.81 X 55.75"
23	F61001102	1	BOARD, CROSS INTERNAL 2.50 X 54.25"
22	F61001008	2	SUPPORT, SPOUT, CONQUEST
21	F10808000	3	BLANK ASSY, SCREEN W/LIP 26.25 X 54.00"
20	F10516200	1	SCREEN BLANK, 3X54" W/LIP
19	F03805600	3	RUBBER HOLD-DOWN STRIP, 51.00"
18	F03805600	2	RUBBER HOLD-DOWN STRIP 73.00"
17	F03805600	2	RUBBER HOLD-DOWN STRIP 61.50"
16	F03805600	2	RUBBER HOLD-DOWN STRIP 35.06"
15	F03500800	16	SCREEN HOOK ASSY, STANDARD
14	F03401702	1	APRON ASSY, 1.25 X 55.75"
13	80016019	16	BOLT, ELEV 1/2-13 X 2.00"
12	70010521	30	SCW, DECK FLT HD #6 X 2.00"
11	66785200	16	NUT, 1/2-13 HEX SERRATED
10	66783800	52	NUT, HEX SERR LOCK 5/16-18
9	66783300	26	NUT, HEX SERR LOCK 1/4-20
8	66445200	12	WASHER, LOCK HELICAL 1/2"
7	66444400	8	WASHER, LOCK HELICAL 3/8"
6	62585226	12	HHCS, 1/2-13 X 1.25"
5	62584426	8	HHCS, 3/8-16 X 1.25"
4	62583837	10	HHCS, 5/16-18 X 2.50"
3	62282712	12	SCW, MACH 10-32 X 1/2" PAN CROSS HEAD
2	60283828	14	BOLT, CARR 5/16-18 X 1.50"
1	60283326	20	BOLT, CARR 1/4-20 X 1.25"

This drawing is the property of the A.T. Ferrell Company, Inc and must be returned immediately upon request. No part of this drawing may be reproduced, stored in a retrieval system or transmitted in any form or by any means, without prior written consent of the A.T. Ferrell Company, Inc	CAD NO MANUAL CHANGES TOLERANCES EXCEPT AS NOTED	DIVISION OF A. T. FERRELL COMPANY BLUFFTON, INDIANA - USA		
	DECIMAL: .005 XX ± .030 FRACTIONAL: 1/32 ANGULAR: ± 1/2°	FINISH: NONE SCALE: 1:8 DRAWN BY: SAH APPROVED BY: DJ	TITLE: ASSY, PRELUDE SHOE DATE: 2/15/2010 SIZE: D PART NUMBER: F61261311 SHEET: 2 of 8	
				
	ITEM PART NUMBER QTY DESCRIPTION			

REVISION HISTORY				
REV	ECN	DESCRIPTION	DATE	APPROVED
A	F100036	REDRAWN IN INVENTOR, UPDATED ASSY	2/22/2010	SH

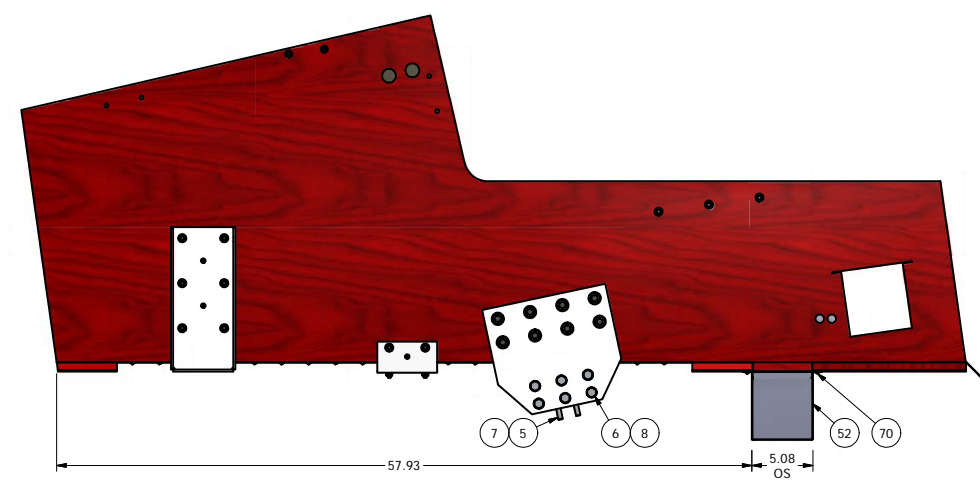
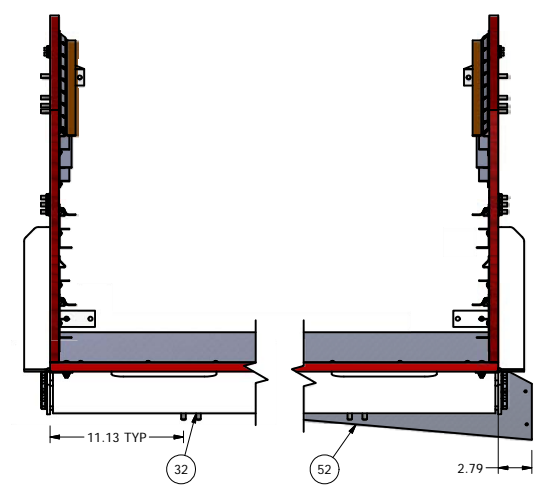

STEP #5: RIGHT SIDE VIEW, SPOUT BRIDGE FASTENER & PITMAN TUBE ASSY
 SCALE 1/8
 RIGHT HAND ASSY SHOWN, INSTALL (F61001258) OPPOSITE FOR LEFT HAND.

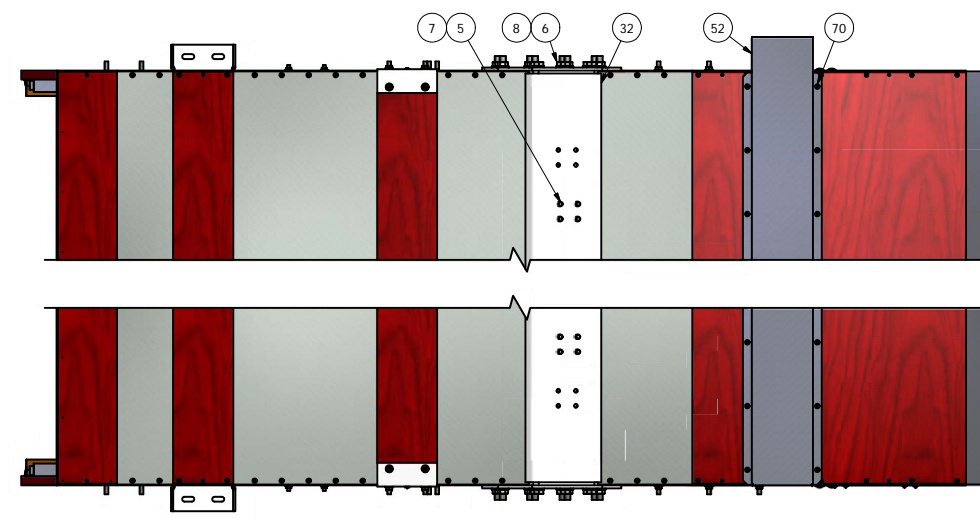

STEP #7: FRONT VIEW, BACK BOARD ASSY
 SCALE 1/8

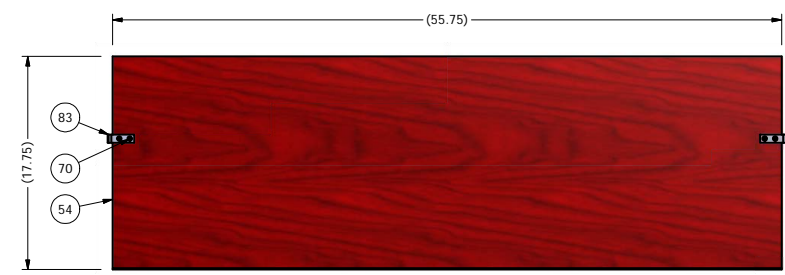
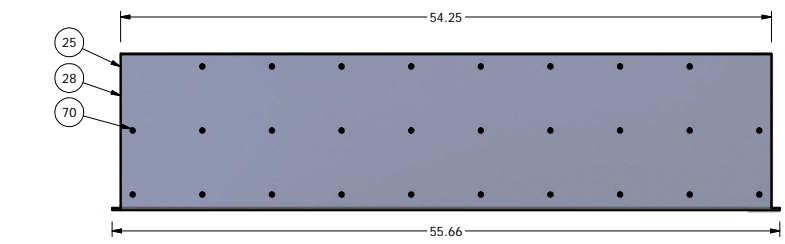

STEP #6: FRONT VIEW, DOOR ASSY
 SCALE 1/8

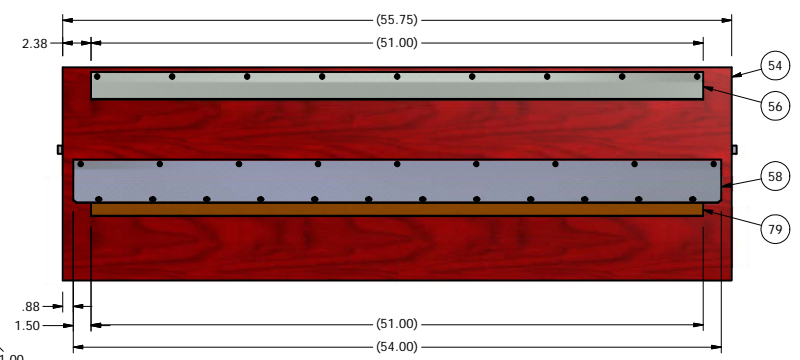
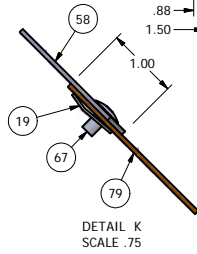
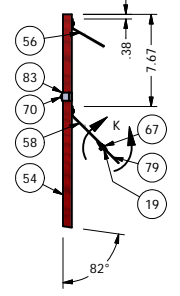

84	SALES ORDER	5	SCREEN ASSY, 26" W/LIP
83	F98600005	2	STRIKE, SCD20650-9XZE
82	F98600005	2	LATCH, SCD 20649 SS
81	F98200006	4	HINGE, TEE 3.00"
80	F92053390	2	SCREEN BLANK ASSY, 9X54" W/LIP
79	F91152006	1	BELTING, 1-PLY .06X2.50X51.00"
78	F91152004	2	BELTING, 3-PLY FSXFS 1.50 X 75.00"
77	F91152004	2	BELTING, 3-PLY FSXFS 1.50 X 63.50"
76	F91152004	2	BELTING, 3-PLY FSXFS 1.50 X 37.06"
75	F91152004	1	BELTING, 1-PLY .06X1.50X51.00"
74	F91151004	1	BELTING, 1-PLY .06 X 4.00 X 51.00"
73	F9008270	5	BALL TRAY WLDMT, 26.25 X 54.00" NG
72	F9005474	2	SCREEN STOP WLDMT, RH NG
71	F9005473	2	SCREEN STOP WLDMT, LH NG
70	F83453402	469	SMS, PHP PAN HD #8 X 3/4"
69	F83440301	38	SMS, FLAT CROSS HEAD #10 X 1.50"
68	F83440135	16	SCW, SMS PAN HD #10 X 1.75"
67	F83200011	23	RIVET, POP SDS64 .188X.125-.250
66	F82631032	12	NUT, KEPS 10-32
65	F82400002	28	NAIL, 14 GA X 3/4" THRD, 7/32" HD T304SS
64	F82071401	2	STUD, DOWEL 1/4-20 X 2.50"
63	F82025603	38	BOLT, ELEV 5/16-18 X 1.50"
62	F82021407	4	BOLT, ELEV 1/4-20 X 1.25"
61	F80026101	240	BALL, RUBBER 1.375 DIA BLACK
60	F62241426	1	BLANK, SCREEN 4.00 X 54.00" W/LIP
59	F62241425	1	SCREEN BLANK ASSY, 5X54" W/LIP
58	F61261328	1	DEFLECTOR, SHOE 4.00"X45
57	F61261325	1	SHOE BOTTOM METAL II, PRELUDE
56	F61261324	1	DEFLECTOR, FRONT, PRELUDE SHOE
55	F61261322	1	SHOE BOTTOM METAL I, PRELUDE
54	F61261321	1	DOOR, PRELUDE SHOE
53	F61261320	2	SIDE, SHOE PRELUDE
52	F61001258	3	SPOUT, DISCHARGE 5 DEG, CONQUEST
51	F61001251	1	PLUG, SPOUT, SHOE SIDE, CONQUEST
50	F61001248	2	BRACKET, SCALP SPOUT, CONQUEST
49	F61001216	1	SPLITTER WLDMT, 50/50 HI-CAP, 9.00" X #8
48	F61001214	1	DEFLECTOR, SPOUT, CONQUEST
47	F61001212	8	BRACKET, CROSS BOARD 5.00"
46	F61001210	2	HANGER SUPPORT, CONQUEST
45	F61001209	2	BOARD, CROSS 7 DEG 5.00 X 55.75"
44	F61001208	5	BOARD, CROSS 5.00 X 55.75"
43	F61001206	2	SCREENWAY RAIL III, 73.00"
42	F61001206	2	SCREENWAY RAIL III, 61.50"
41	F61001206	2	SCREENWAY RAIL III, 58.50"
40	F61001206	2	SCREENWAY RAIL III, 35.06"
39	F61001206	2	SCREENWAY RAIL III, 26.25"
38	F61001205	2	SCREENWAY RAIL II, 58.50"
37	F61001205	2	SCREENWAY RAIL II, 26.25"
36	F61001204	2	SCREENWAY RAIL I, 73.00"
35	F61001204	2	SCREENWAY RAIL I, 61.50"
34	F61001204	2	SCREENWAY RAIL I, 35.06"
33	F61001203	2	PLATE, PITMAN, CONQUEST
32	F61001200	1	PITMAN WLDMT, 55.75"
31	F61001116	1	DIVERTER ASSY, 8.00X54.00", BTM SHOE, CNQST
30	F61001112	2	END IRON, BOTTOM SHOE, CONQUEST
29	F61001111	1	COVER, SPOUT HOLE, BTM SHOE, CONQUEST
28	F61001110	1	BACK MTL, BTM SHOE, CONQUEST 1360
27	F61001109	1	MTL III, BTM, BTM SHOE, CONQUEST 1360
26	F61001106	2	SPACER, HANGER, BTM SHOE, CONQUEST
25	F61001104	1	BOARD, BACK, BOTTOM SHOE, CONQUEST 1360
24	F61001103	2	BOARD, CROSS 12.81 X 55.75"
23	F61001102	1	BOARD, CROSS INTERNAL 2.50 X 54.25"
22	F61001008	2	SUPPORT, SPOUT, CONQUEST
21	F10808000	3	BLANK ASSY, SCREEN W/LIP 26.25 X 54.00"
20	F10516200	1	SCREEN BLANK, 3X54" W/LIP
19	F03805600	3	RUBBER HOLD-DOWN STRIP, 51.00"
18	F03805600	2	RUBBER HOLD-DOWN STRIP 73.00"
17	F03805600	2	RUBBER HOLD-DOWN STRIP 61.50"
16	F03805600	2	RUBBER HOLD-DOWN STRIP 35.06"
15	F03500800	16	SCREEN HOOK ASSY, STANDARD
14	F03401702	1	APRON ASSY, 1.25 X 55.75"
13	80016019	16	BOLT, ELEV 1/2-13 X 2.00"
12	70010521	30	SCW, DECK FLT HD #6 X 2.00"
11	66785200	16	NUT, 1/2-13 HEX SERRATED
10	66783800	52	NUT, HEX SERR LOCK 5/16-18
9	66783300	26	NUT, HEX SERR LOCK 1/4-20
8	66445200	12	WASHER, LOCK HELICAL 1/2"
7	66444400	8	WASHER, LOCK HELICAL 3/8"
6	62585226	12	HHCS, 1/2-13 X 1.25"
5	62584426	8	HHCS, 3/8-16 X 1.25"
4	62583837	10	HHCS, 5/16-18 X 2.50"
3	62282712	12	SCW, MACH 10-32 X 1/2" PAN CROSS HEAD
2	60283828	14	BOLT, CARR 5/16-18 X 1.50"
1	60283326	20	BOLT, CARR 1/4-20 X 1.25"

This drawing is the property of the A.T. Ferrell Company, Inc and must be returned immediately upon request. No part of this drawing may be reproduced, stored in a retrieval system or transmitted in any form or by any means, without prior written consent of the A.T. Ferrell Company, Inc	CAD NO MANUAL CHANGES			
	TOLERANCES EXCEPT AS NOTED DECIMAL: .005 .010 .020 FRACTIONAL: 1/32 ANGULAR: 1/2	FINISH: NONE SCALE: 1:8 DRAWN BY: SAH APPROVED BY: DJ	DIVISION OF A. T. FERRELL COMPANY BLUFFTON, INDIANA - USA	
	TITLE: ASSY, PRELUDE SHOE DATE: 2/15/2010 SIZE: D PART NUMBER: F61261311	SHEET: 3 of 8		
	ITEM PART NUMBER QTY DESCRIPTION			

REVISION HISTORY				
REV	ECN	DESCRIPTION	DATE	APPROVED
A	F100036	REDRAWN IN INVENTOR, UPDATED ASSY	2/22/2010	SH

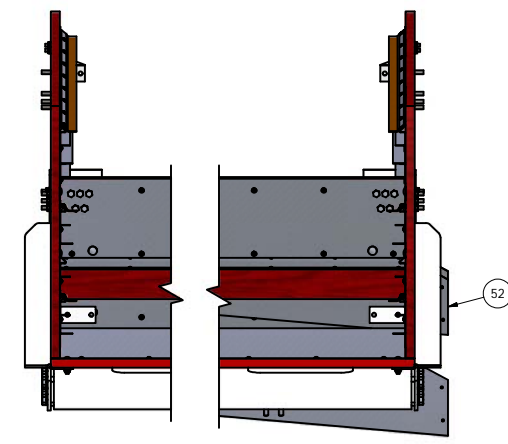
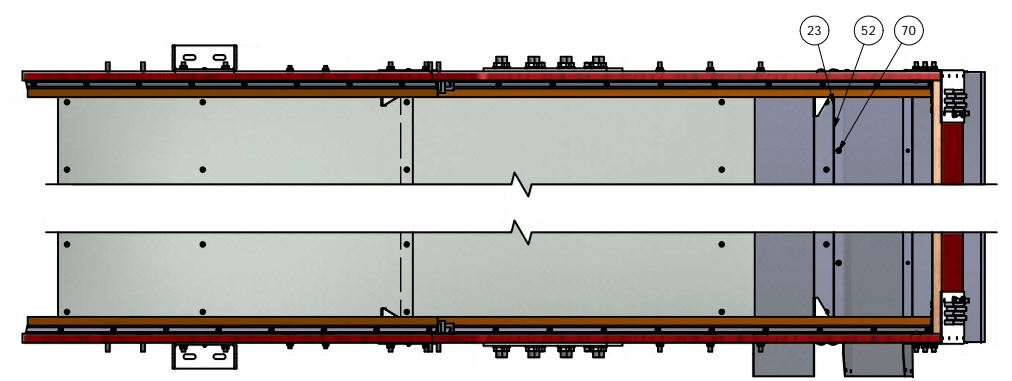

RIGHT HAND ASSY SHOWN, INSTALL (F61001258) OPPOSITE FOR LEFT HAND.

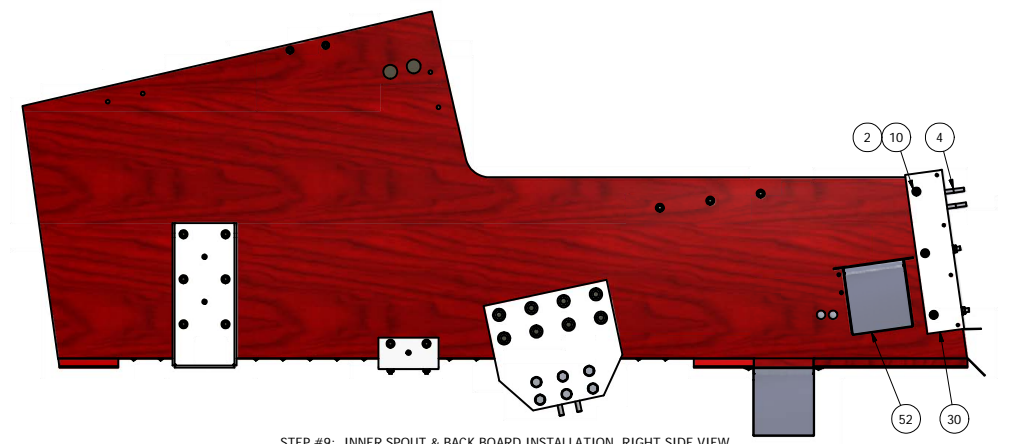

STEP #9: INNER SPOUT & BACK BOARD INSTALLATION, RIGHT SIDE VIEW
SCALE 1/8

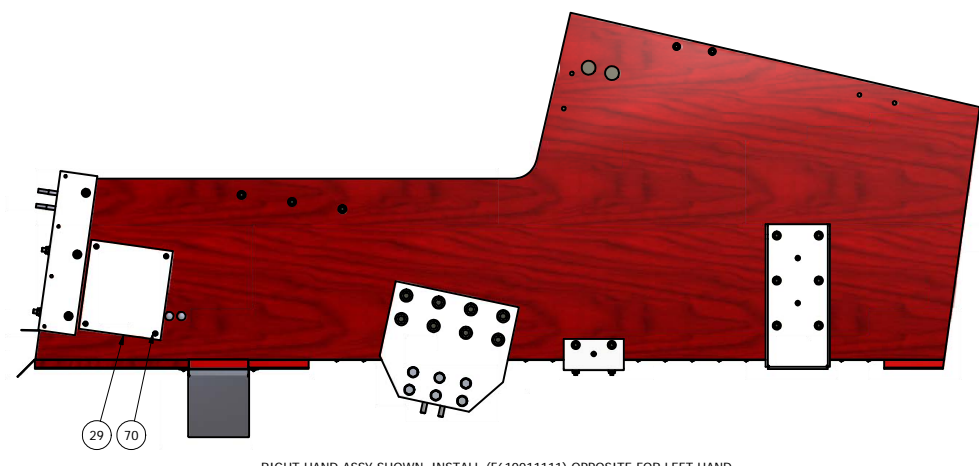
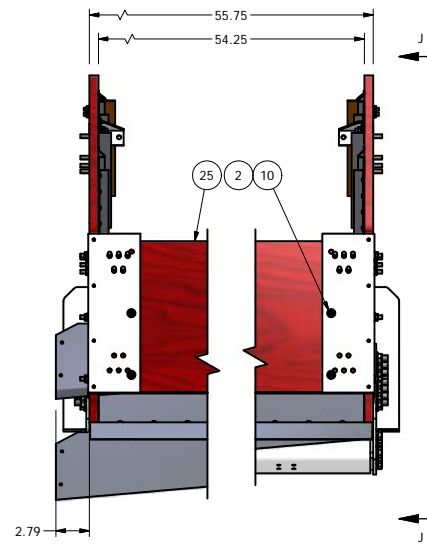

RIGHT HAND ASSY SHOWN, INSTALL (F61001111) OPPOSITE FOR LEFT HAND.

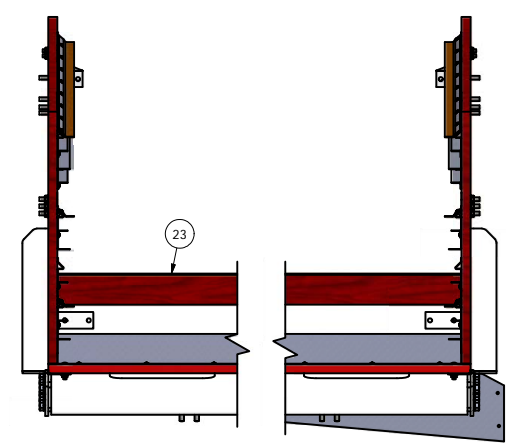

STEP #8: INNER CROSSBOARD INSTALLATION, FRONT VIEW
SCALE 1/8

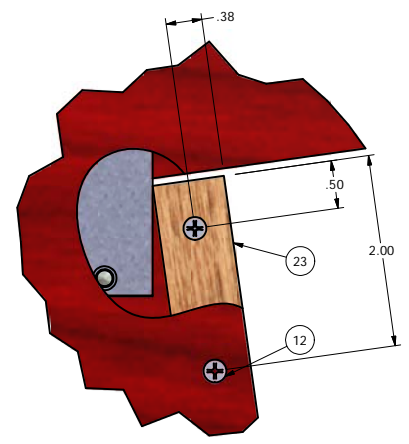
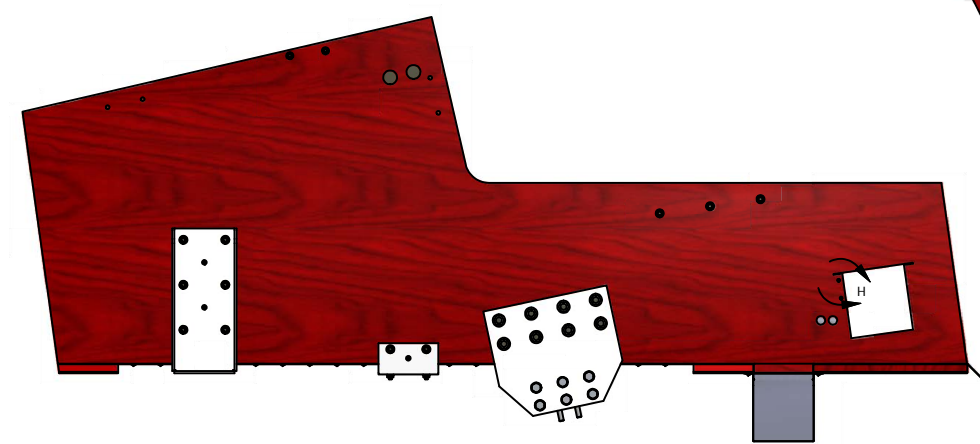

DETAIL H
SCALE 1

84	SALES ORDER	5	SCREEN ASSY, 26" W/LIP
83	F98600005	2	STRIKE, SCD20650-9XZE
82	F98600005	2	LATCH, SCD 20649 SS
81	F98200006	4	HINGE, TEE 3.00"
80	F92053390	2	SCREEN BLANK ASSY, 9X54" W/LIP
79	F91152006	1	BELTING, 1-PLY .06X2.50X51.00"
78	F91152004	2	BELTING, 3-PLY FSXFS 1.50 X 75.00"
77	F91152004	2	BELTING, 3-PLY FSXFS 1.50 X 63.50"
76	F91152004	2	BELTING, 3-PLY FSXFS 1.50 X 37.06"
75	F91152004	1	BELTING, 1-PLY .06X1.50X51.00"
74	F91151004	1	BELTING, 1-PLY .06 X 4.00 X 51.00"
73	F90008270	5	BALL TRAY WLDMT, 26.25 X 54.00" NG
72	F90005474	2	SCREEN STOP WLDMT, RH NG
71	F90005473	2	SCREEN STOP WLDMT, LH NG
70	F83453402	469	SMS, PHP PAN HD #8 X 3/4"
69	F83440301	38	SMS, FLAT CROSS HEAD #10 X 1.50"
68	F83440135	16	SCW, SMS PAN HD #10 X 1.75"
67	F83200011	23	RIVET, POP SDS64 .188X.125-.250
66	F82631032	12	NUT, KEPS 10-32
65	F82400002	28	NAIL, 14 GA X 3/4" THRD, 7/32" HD T304SS
64	F82071401	2	STUD, DOWEL 1/4-20 X 2.50"
63	F82025603	38	BOLT, ELEV 5/16-18 X 1.50"
62	F82021407	4	BOLT, ELEV 1/4-20 X 1.25"
61	F80026101	240	BALL, RUBBER 1.375 DIA BLACK
60	F62241426	1	BLANK, SCREEN 4.00 X 54.00" W/LIP
59	F62241425	1	SCREEN BLANK ASSY, 5X54" W/LIP
58	F61261328	1	DEFLECTOR, SHOE 4.00"X45
57	F61261325	1	SHOE BOTTOM METAL II, PRELUDE
56	F61261324	1	DEFLECTOR, FRONT, PRELUDE SHOE
55	F61261322	1	SHOE BOTTOM METAL I, PRELUDE
54	F61261321	1	DOOR, PRELUDE SHOE
53	F61261320	2	SIDE, SHOE PRELUDE
52	F61001258	3	SPOUT, DISCHARGE 5 DEG, CONQUEST
51	F61001251	1	PLUG, SPOUT, SHOE SIDE, CONQUEST
50	F61001248	2	BRACKET, SCALP SPOUT, CONQUEST
49	F61001216	1	SPLITTER WLDMT, 50/50 HI-CAP, 9.00" X #8
48	F61001214	1	DEFLECTOR, SPOUT, CONQUEST
47	F61001212	8	BRACKET, CROSS BOARD 5.00"
46	F61001210	2	HANGER SUPPORT, CONQUEST
45	F61001209	2	BOARD, CROSS 7 DEG 5.00 X 55.75"
44	F61001208	5	BOARD, CROSS 5.00 X 55.75"
43	F61001206	2	SCREENWAY RAIL III, 73.00"
42	F61001206	2	SCREENWAY RAIL III, 61.50"
41	F61001206	2	SCREENWAY RAIL III, 58.50"
40	F61001206	2	SCREENWAY RAIL III, 35.06"
39	F61001206	2	SCREENWAY RAIL III, 26.25"
38	F61001205	2	SCREENWAY RAIL II, 58.50"
37	F61001205	2	SCREENWAY RAIL II, 26.25"
36	F61001204	2	SCREENWAY RAIL I, 73.00"
35	F61001204	2	SCREENWAY RAIL I, 61.50"
34	F61001204	2	SCREENWAY RAIL I, 35.06"
33	F61001203	2	PLATE, PITMAN, CONQUEST
32	F61001200	1	PITMAN WLDMT, 55.75"
31	F61001116	1	DIVERTER ASSY, 8.00X54.00", BTM SHOE, CNQST
30	F61001112	2	END IRON, BOTTOM SHOE, CONQUEST
29	F61001111	1	COVER, SPOUT HOLE, BTM SHOE, CONQUEST
28	F61001110	1	BACK MTL, BTM SHOE, CONQUEST 1360
27	F61001109	1	MTL III, BTM, BTM SHOE, CONQUEST 1360
26	F61001106	2	SPACER, HANGER, BTM SHOE, CONQUEST
25	F61001104	1	BOARD, BACK, BOTTOM SHOE, CONQUEST 1360
24	F61001103	2	BOARD, CROSS 12.81 X 55.75"
23	F61001102	1	BOARD, CROSS INTERNAL 2.50 X 54.25"
22	F61001008	2	SUPPORT, SPOUT, CONQUEST
21	F10808000	3	BLANK ASSY, SCREEN W/LIP 26.25 X 54.00"
20	F10516200	1	SCREEN BLANK, 3X54" W/LIP
19	F03805600	3	RUBBER HOLD-DOWN STRIP, 51.00"
18	F03805600	2	RUBBER HOLD-DOWN STRIP 73.00"
17	F03805600	2	RUBBER HOLD-DOWN STRIP 61.50"
16	F03805600	2	RUBBER HOLD-DOWN STRIP 35.06"
15	F03500800	16	SCREEN HOOK ASSY, STANDARD
14	F03401702	1	APRON ASSY, 1.25 X 55.75"
13	80016019	16	BOLT, ELEV 1/2-13 X 2.00"
12	70010521	30	SCW, DECK FLT HD #6 X 2.00"
11	66785200	16	NUT, 1/2-13 HEX SERRATED
10	66783800	52	NUT, HEX SERR LOCK 5/16-18
9	66783300	26	NUT, HEX SERR LOCK 1/4-20
8	66445200	12	WASHER, LOCK HELICAL 1/2"
7	66444400	8	WASHER, LOCK HELICAL 3/8"
6	62585226	12	HHCS, 1/2-13 X 1.25"
5	62584426	8	HHCS, 3/8-16 X 1.25"
4	62583837	10	HHCS, 5/16-18 X 2.50"
3	62282712	12	SCW, MACH 10-32 X 1/2" PAN CROSS HEAD
2	60283828	14	BOLT, CARR 5/16-18 X 1.50"
1	60283326	20	BOLT, CARR 1/4-20 X 1.25"

This drawing is the property of the A.T. Ferrell Company, Inc and must be returned immediately upon request. No part of this drawing may be reproduced, stored in a retrieval system or transmitted in any form or by any means, without prior written consent of the A.T. Ferrell Company, Inc	CAD NO MANUAL CHANGES	DIVISION OF A. T. FERRELL COMPANY		BLUFFTON, INDIANA - USA		
	TOLERANCES EXCEPT AS NOTED DECIMAL: .005 .010 .020 FRACTIONAL: 1/32 ANGULAR: 1/2°	FINISH: NONE SCALE: 1:8 DRAWN BY: SAH APPROVED BY: DJ	TITLE: ASSY, PRELUDE SHOE		SHEET: 4 of 8	
	DATE: 2/15/2010		SIZE: D	PART NUMBER: F61261311		SHEET: 4 of 8

REVISION HISTORY				
REV	ECN	DESCRIPTION	DATE	APPROVED
A	F100036	REDRAWN IN INVENTOR, UPDATED ASSY	2/22/2010	SH

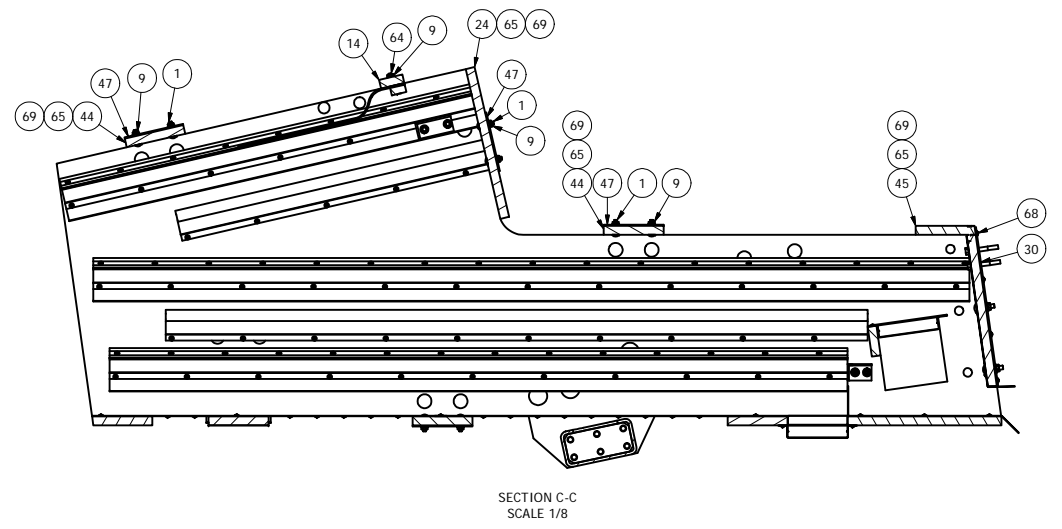
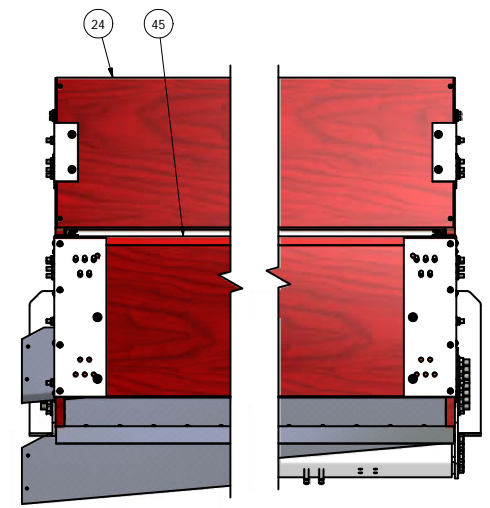
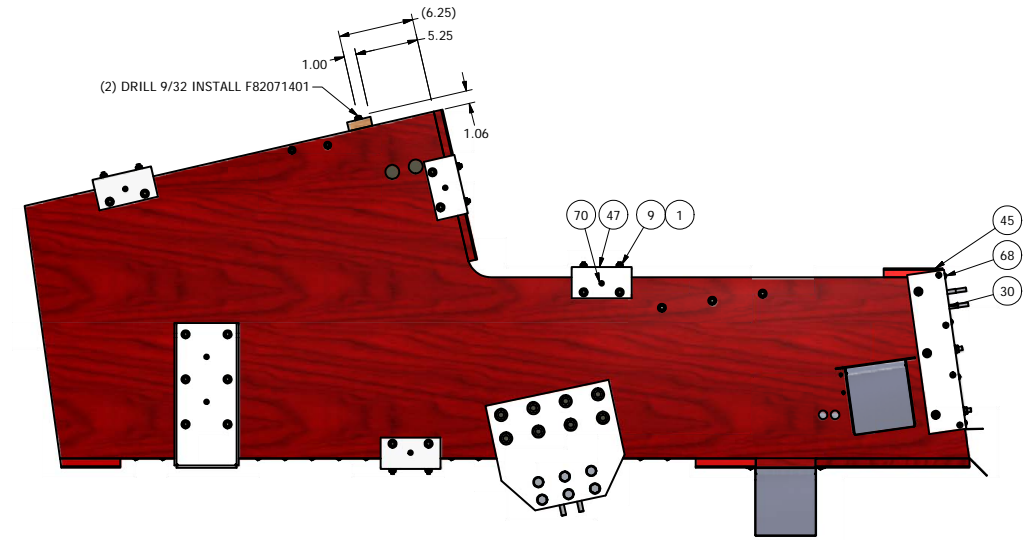
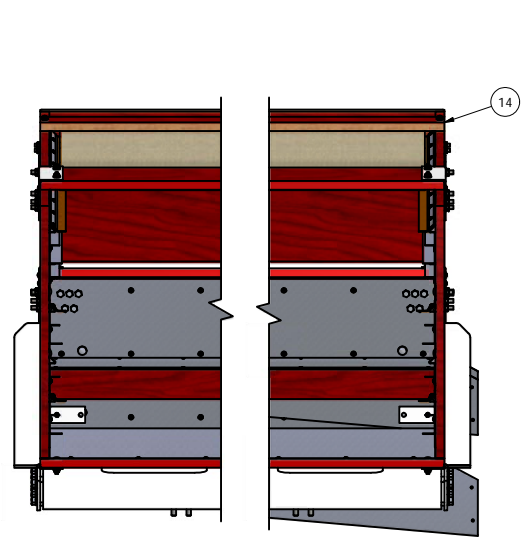
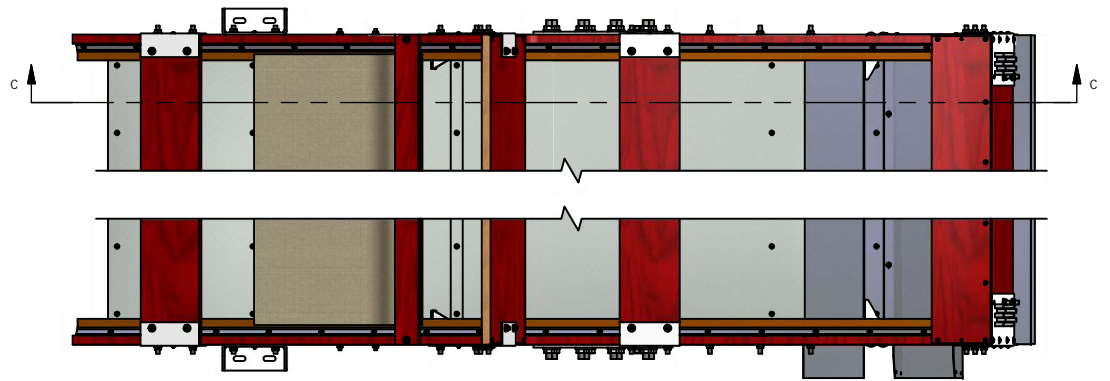

ITEM	PART NUMBER	QTY	DESCRIPTION
84	SALES ORDER	5	SCREEN ASSY, 26" W/LIP
83	F98600005	2	STRIKE, SCD20650-9XZE
82	F98600005	2	LATCH, SCD 20649 SS
81	F98200006	4	HINGE, TEE 3.00"
80	F92053390	2	SCREEN BLANK ASSY, 9X54" W/LIP
79	F91152006	1	BELTING, 1-PLY .06X2.50X51.00"
78	F91152004	2	BELTING, 3-PLY FSXFS 1.50 X 75.00"
77	F91152004	2	BELTING, 3-PLY FSXFS 1.50 X 63.50"
76	F91152004	2	BELTING, 3-PLY FSXFS 1.50 X 37.06"
75	F91152004	1	BELTING, 1-PLY .06X1.50X51.00"
74	F91151004	1	BELTING, 1-PLY .06 X 4.00 X 51.00"
73	F90008270	5	BALL TRAY WLDMT, 26.25 X 54.00" NG
72	F90005474	2	SCREEN STOP WLDMT, RH NG
71	F90005473	2	SCREEN STOP WLDMT, LH NG
70	F83453402	469	SMS, PHP PAN HD #8 X 3/4"
69	F83440301	38	SMS, FLAT CROSS HEAD #10 X 1.50"
68	F83440135	16	SCW, SMS PAN HD #10 X 1.75"
67	F83200011	23	RIVET, POP SDS64 .188X.125-.250
66	F82631032	12	NUT, KEPS 10-32
65	F82400002	28	NAIL, 14 GA X 3/4" THRD, 7/32" HD T304SS
64	F82071401	2	STUD, DOWEL 1/4-20 X 2.50"
63	F82025603	38	BOLT, ELEV 5/16-18 X 1.50"
62	F82021407	4	BOLT, ELEV 1/4-20 X 1.25"
61	F80026101	240	BALL, RUBBER 1.375 DIA BLACK
60	F62241426	1	BLANK, SCREEN 4.00 X 54.00" W/LIP
59	F62241425	1	SCREEN BLANK ASSY, 5X54" W/LIP
58	F61261328	1	DEFLECTOR, SHOE 4.00"X45
57	F61261325	1	SHOE BOTTOM METAL II, PRELUDE
56	F61261324	1	DEFLECTOR, FRONT, PRELUDE SHOE
55	F61261322	1	SHOE BOTTOM METAL I, PRELUDE
54	F61261321	1	DOOR, PRELUDE SHOE
53	F61261320	2	SIDE, SHOE PRELUDE
52	F61001258	3	SPOUT, DISCHARGE 5 DEG, CONQUEST
51	F61001251	1	PLUG, SPOUT, SHOE SIDE, CONQUEST
50	F61001248	2	BRACKET, SCALP SPOUT, CONQUEST
49	F61001216	1	SPLITTER WLDMT, 50/50 HI-CAP, 9.00" X #8
48	F61001214	1	DEFLECTOR, SPOUT, CONQUEST
47	F61001212	8	BRACKET, CROSS BOARD 5.00"
46	F61001210	2	HANGER SUPPORT, CONQUEST
45	F61001209	2	BOARD, CROSS 7 DEG 5.00 X 55.75"
44	F61001208	5	BOARD, CROSS 5.00 X 55.75"
43	F61001206	2	SCREENWAY RAIL III, 73.00"
42	F61001206	2	SCREENWAY RAIL III, 61.50"
41	F61001206	2	SCREENWAY RAIL III, 58.50"
40	F61001206	2	SCREENWAY RAIL III, 35.06"
39	F61001206	2	SCREENWAY RAIL III, 26.25"
38	F61001205	2	SCREENWAY RAIL II, 58.50"
37	F61001205	2	SCREENWAY RAIL II, 26.25"
36	F61001204	2	SCREENWAY RAIL I, 73.00"
35	F61001204	2	SCREENWAY RAIL I, 61.50"
34	F61001204	2	SCREENWAY RAIL I, 35.06"
33	F61001203	2	PLATE, PITMAN, CONQUEST
32	F61001200	1	PITMAN WLDMT, 55.75"
31	F61001116	1	DIVERTER ASSY, 8.00X54.00", BTM SHOE, CNQST
30	F61001112	2	END IRON, BOTTOM SHOE, CONQUEST
29	F61001111	1	COVER, SPOUT HOLE, BTM SHOE, CONQUEST
28	F61001110	1	BACK MTL, BTM SHOE, CONQUEST 1360
27	F61001109	1	MTL III, BTM, BTM SHOE, CONQUEST 1360
26	F61001106	2	SPACER, HANGER, BTM SHOE, CONQUEST
25	F61001104	1	BOARD, BACK, BOTTOM SHOE, CONQUEST 1360
24	F61001103	2	BOARD, CROSS 12.81 X 55.75"
23	F61001102	1	BOARD, CROSS INTERNAL 2.50 X 54.25"
22	F61001008	2	SUPPORT, SPOUT, CONQUEST
21	F10808000	3	BLANK ASSY, SCREEN W/LIP 26.25 X 54.00"
20	F10516200	1	SCREEN BLANK, 3X54" W/LIP
19	F03805600	3	RUBBER HOLD-DOWN STRIP, 51.00"
18	F03805600	2	RUBBER HOLD-DOWN STRIP 73.00"
17	F03805600	2	RUBBER HOLD-DOWN STRIP 61.50"
16	F03805600	2	RUBBER HOLD-DOWN STRIP 35.06"
15	F03500800	16	SCREEN HOOK ASSY, STANDARD
14	F03401702	1	APRON ASSY, 1.25 X 55.75"
13	80016019	16	BOLT, ELEV 1/2-13 X 2.00"
12	70010521	30	SCW, DECK FLT HD #6 X 2.00"
11	66785200	16	NUT, 1/2-13 HEX SERRATED
10	66783800	52	NUT, HEX SERR LOCK 5/16-18
9	66783300	26	NUT, HEX SERR LOCK 1/4-20
8	66445200	12	WASHER, LOCK HELICAL 1/2"
7	66444400	8	WASHER, LOCK HELICAL 3/8"
6	62585226	12	HHCS, 1/2-13 X 1.25"
5	62584426	8	HHCS, 3/8-16 X 1.25"
4	62583837	10	HHCS, 5/16-18 X 2.50"
3	62282712	12	SCW, MACH 10-32 X 1/2" PAN CROSS HEAD
2	60283828	14	BOLT, CARR 5/16-18 X 1.50"
1	60283326	20	BOLT, CARR 1/4-20 X 1.25"

This drawing is the property of the A.T. Ferrell Company, Inc and must be returned immediately upon request. No part of this drawing may be reproduced, stored in a retrieval system or transmitted in any form or by any means, without prior written consent of the A.T. Ferrell Company, Inc

CAD
NO MANUAL CHANGES
TOLERANCES EXCEPT AS NOTED

DECIMAL: .005
XX ± .030
FRACTIONAL: 1/32
ANGULAR: ± 1/2°

DIVISION OF A. T. FERRELL COMPANY
BLUFFTON, INDIANA - USA

FINISH: NONE
SCALE: 1:8
DRAWN BY: SAH
APPROVED BY: DJ

TITLE: ASSY, PRELUDE SHOE

DATE: 2/15/2010
SIZE: D
PART NUMBER: **F61261311**
SHEET: 5 of 8



REVISION HISTORY				
REV	ECN	DESCRIPTION	DATE	APPROVED
A	F100036	REDRAWN IN INVENTOR, UPDATED ASSY	2/22/2010	SH

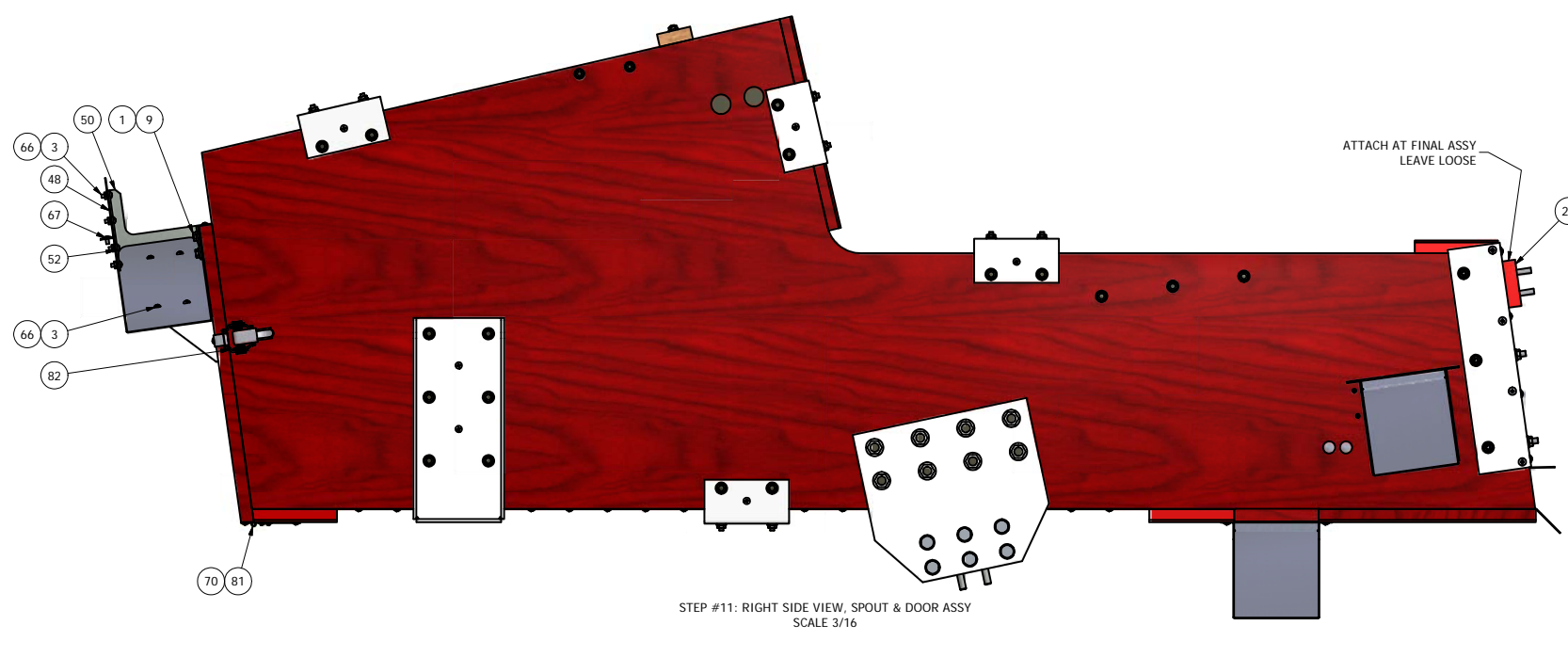
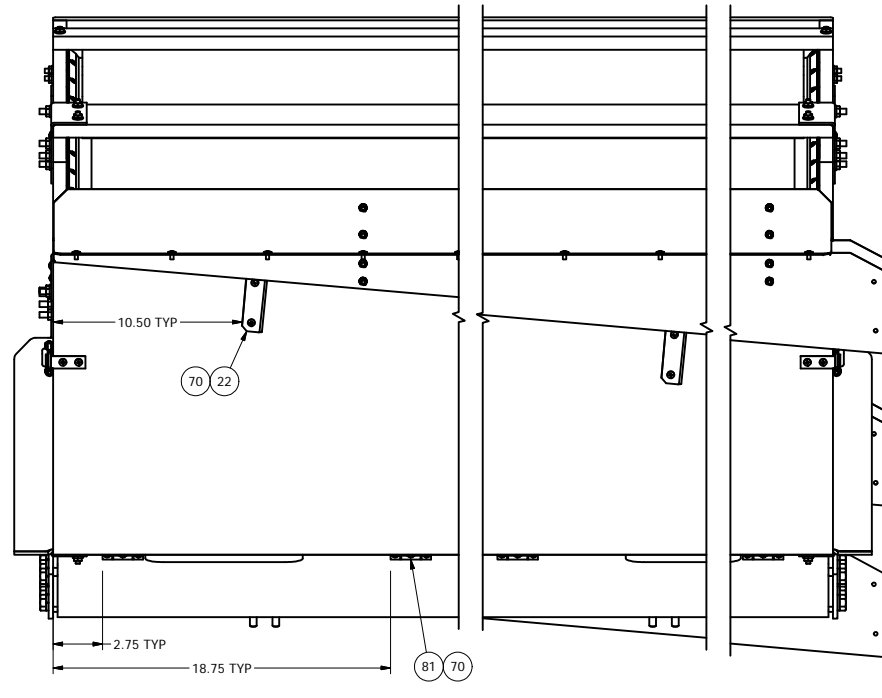
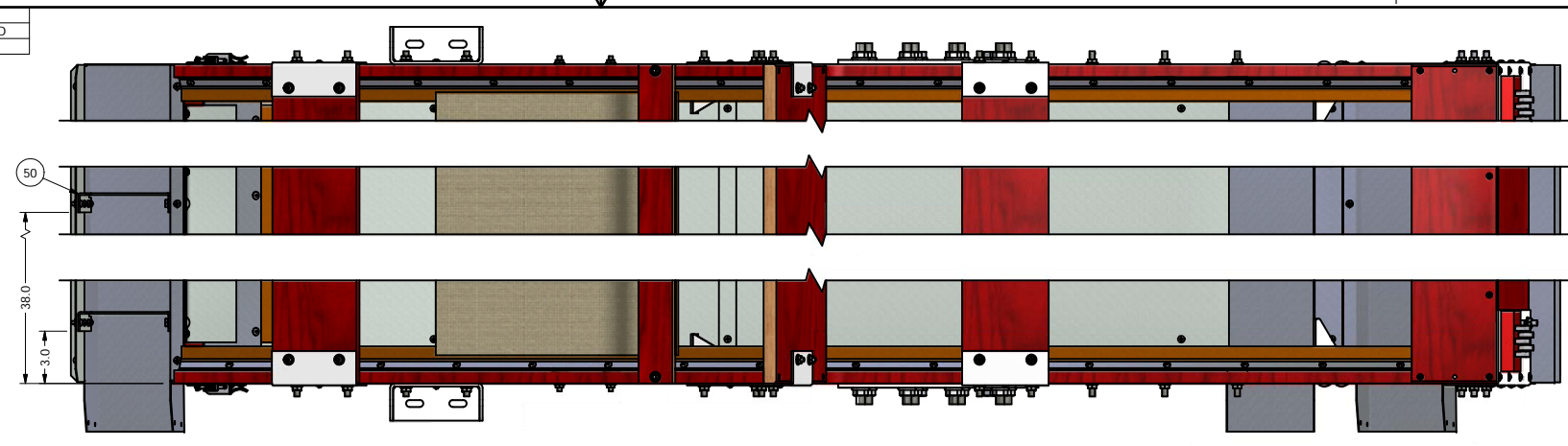

RIGHT HAND ASSY SHOWN, INSTALL (F61001258) OPPOSITE FOR LEFT HAND.

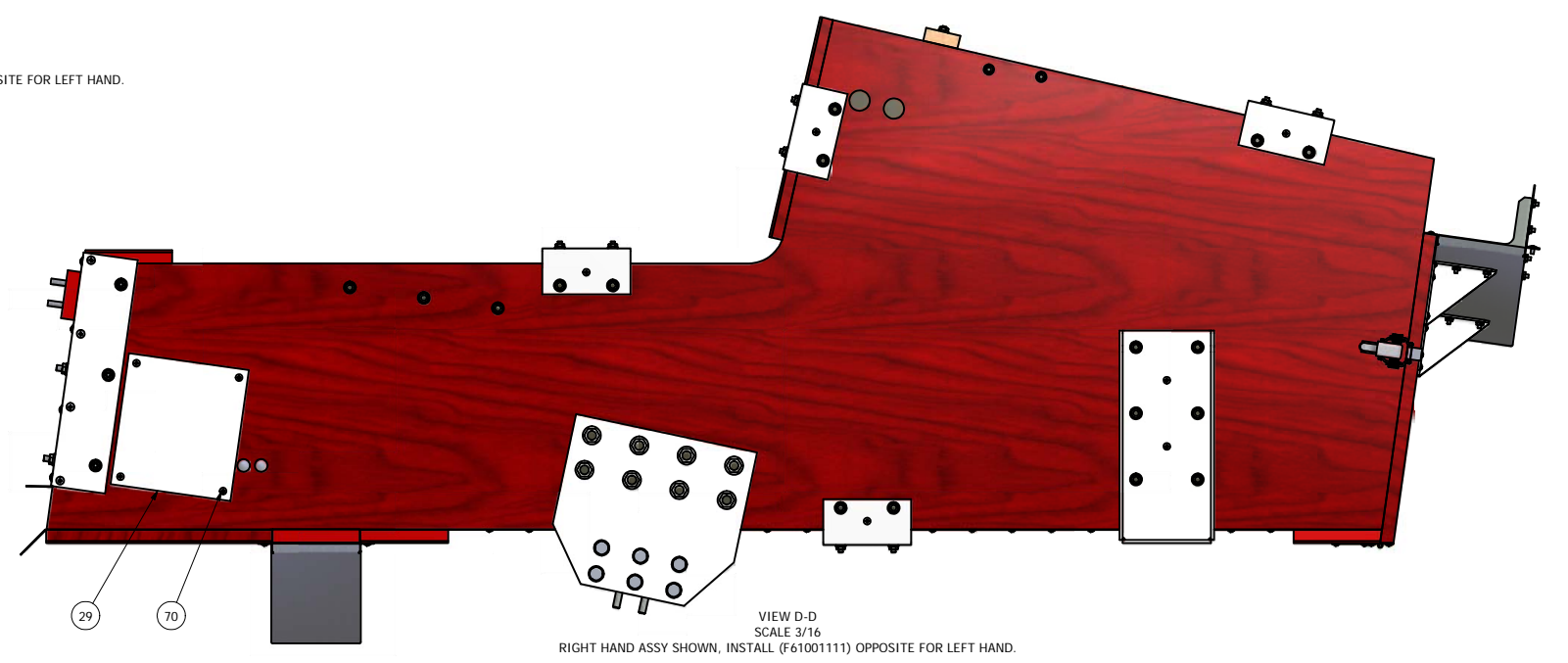

84	SALES ORDER	5	SCREEN ASSY, 26" W/LIP
83	F98600005	2	STRIKE, SCD20650-9XZE
82	F98600005	2	LATCH, SCD 20649 SS
81	F98200006	4	HINGE, TEE 3.00"
80	F92053390	2	SCREEN BLANK ASSY, 9X54" W/LIP
79	F91152006	1	BELTING, 1-PLY .06X2.50X51.00"
78	F91152004	2	BELTING, 3-PLY FSXFS 1.50 X 75.00"
77	F91152004	2	BELTING, 3-PLY FSXFS 1.50 X 63.50"
76	F91152004	2	BELTING, 3-PLY FSXFS 1.50 X 37.06"
75	F91152004	1	BELTING, 1-PLY .06X1.50X51.00"
74	F91151004	1	BELTING, 1-PLY .06 X 4.00 X 1.75"
73	F90008270	5	BALL TRAY WLDMT, 26.25 X 54.00" NG
72	F90005474	2	SCREEN STOP WLDMT, RH NG
71	F90005473	2	SCREEN STOP WLDMT, LH NG
70	F83453402	469	SMS, PHP PAN HD #8 X 3/4"
69	F83440301	38	SMS, FLAT CROSS HEAD #10 X 1.50"
68	F83440135	16	SCW, SMS PAN HD #10 X 1.75"
67	F83200011	23	RIVET, POP SDS64 .188X.125-.250
66	F82631032	12	NUT, KEPS 10-32
65	F82400002	28	NAIL, 14 GA X 3/4" THRD, 7/32" HD T304SS
64	F82071401	2	STUD, DOWEL 1/4-20 X 2.50"
63	F82025603	38	BOLT, ELEV 5/16-18 X 1.50"
62	F82021407	4	BOLT, ELEV 1/4-20 X 1.25"
61	F80026101	240	BALL, RUBBER 1.375 DIA BLACK
60	F62241426	1	BLANK, SCREEN 4.00 X 54.00" W/LIP
59	F62241425	1	SCREEN BLANK ASSY, 5X54" W/LIP
58	F61261328	1	DEFLECTOR, SHOE 4.00"X45
57	F61261325	1	SHOE BOTTOM METAL II, PRELUDE
56	F61261324	1	DEFLECTOR, FRONT, PRELUDE SHOE
55	F61261322	1	SHOE BOTTOM METAL I, PRELUDE
54	F61261321	1	DOOR, PRELUDE SHOE
53	F61261320	2	SIDE, SHOE PRELUDE
52	F61001258	3	SPOUT, DISCHARGE 5 DEG, CONQUEST
51	F61001251	1	PLUG, SPOUT, SHOE SIDE, CONQUEST
50	F61001248	2	BRACKET, SCALP SPOUT, CONQUEST
49	F61001216	1	SPLITTER WLDMT, 50/50 HI-CAP, 9.00" X #8
48	F61001214	1	DEFLECTOR, SPOUT, CONQUEST
47	F61001212	8	BRACKET, CROSS BOARD 5.00"
46	F61001210	2	HANGER SUPPORT, CONQUEST
45	F61001209	2	BOARD, CROSS 7 DEG 5.00 X 55.75"
44	F61001208	5	BOARD, CROSS 5.00 X 55.75"
43	F61001206	2	SCREENWAY RAIL III, 73.00"
42	F61001206	2	SCREENWAY RAIL III, 61.50"
41	F61001206	2	SCREENWAY RAIL III, 58.50"
40	F61001206	2	SCREENWAY RAIL III, 35.06"
39	F61001206	2	SCREENWAY RAIL III, 26.25"
38	F61001205	2	SCREENWAY RAIL II, 58.50"
37	F61001205	2	SCREENWAY RAIL II, 26.25"
36	F61001204	2	SCREENWAY RAIL I, 73.00"
35	F61001204	2	SCREENWAY RAIL I, 61.50"
34	F61001204	2	SCREENWAY RAIL I, 35.06"
33	F61001203	2	PLATE, PITMAN, CONQUEST
32	F61001200	1	PITMAN WLDMT, 55.75"
31	F61001116	1	DIVERTER ASSY, 8.00X54.00", BTM SHOE, CNQST
30	F61001112	2	END IRON, BOTTOM SHOE, CONQUEST
29	F61001111	1	COVER, SPOUT HOLE, BTM SHOE, CONQUEST
28	F61001110	1	BACK MTL, BTM SHOE, CONQUEST 1360
27	F61001109	1	MTL III, BTM, BTM SHOE, CONQUEST 1360
26	F61001106	2	SPACER, HANGER, BTM SHOE, CONQUEST
25	F61001104	1	BOARD, BACK, BOTTOM SHOE, CONQUEST 1360
24	F61001103	2	BOARD, CROSS 12.81 X 55.75"
23	F61001102	1	BOARD, CROSS INTERNAL 2.50 X 54.25"
22	F61001008	2	SUPPORT, SPOUT, CONQUEST
21	F10808000	3	BLANK ASSY, SCREEN W/LIP 26.25 X 54.00"
20	F10516200	1	SCREEN BLANK, 3X54" W/LIP
19	F03805600	3	RUBBER HOLD-DOWN STRIP, 51.00"
18	F03805600	2	RUBBER HOLD-DOWN STRIP 73.00"
17	F03805600	2	RUBBER HOLD-DOWN STRIP 61.50"
16	F03805600	2	RUBBER HOLD-DOWN STRIP 35.06"
15	F03500800	16	SCREEN HOOK ASSY, STANDARD
14	F03401702	1	APRON ASSY, 1.25 X 55.75"
13	80016019	16	BOLT, ELEV 1/2-13 X 2.00"
12	70010521	30	SCW, DECK FLT HD #6 X 2.00"
11	66785200	16	NUT, 1/2-13 HEX SERRATED
10	66783800	52	NUT, HEX SERR LOCK 5/16-18
9	66783300	26	NUT, HEX SERR LOCK 1/4-20
8	66445200	12	WASHER, LOCK HELICAL 1/2"
7	66444400	8	WASHER, LOCK HELICAL 3/8"
6	62585226	12	HHCS, 1/2-13 X 1.25"
5	62584426	8	HHCS, 3/8-16 X 1.25"
4	62583837	10	HHCS, 5/16-18 X 2.50"
3	62282712	12	SCW, MACH 10-32 X 1/2" PAN CROSS HEAD
2	60283828	14	BOLT, CARR 5/16-18 X 1.50"
1	60283326	20	BOLT, CARR 1/4-20 X 1.25"

This drawing is the property of the A.T. Ferrell Company, Inc and must be returned immediately upon request. No part of this drawing may be reproduced, stored in a retrieval system or transmitted in any form or by any means, without prior written consent of the A.T. Ferrell Company, Inc	CAD NO MANUAL CHANGES	DIVISION OF A. T. FERRELL COMPANY BLUFFTON, INDIANA - USA		
	TOLERANCES EXCEPT AS NOTED DECIMAL: .005 .010 .020 FRACTIONAL: 1/32 ANGULAR: ± 1/2°	FINISH: NONE SCALE: 1:8 DRAWN BY: SAH APPROVED BY: DJ	TITLE: ASSY, PRELUDE SHOE DATE: 2/15/2010 SIZE: D PART NUMBER: F61261311 SHEET: 6 of 8	
	SHEET: 6 of 8			

REVISION HISTORY				
REV	ECN	DESCRIPTION	DATE	APPROVED
A	F100036	REDRAWN IN INVENTOR, UPDATED ASSY	2/22/2010	SH

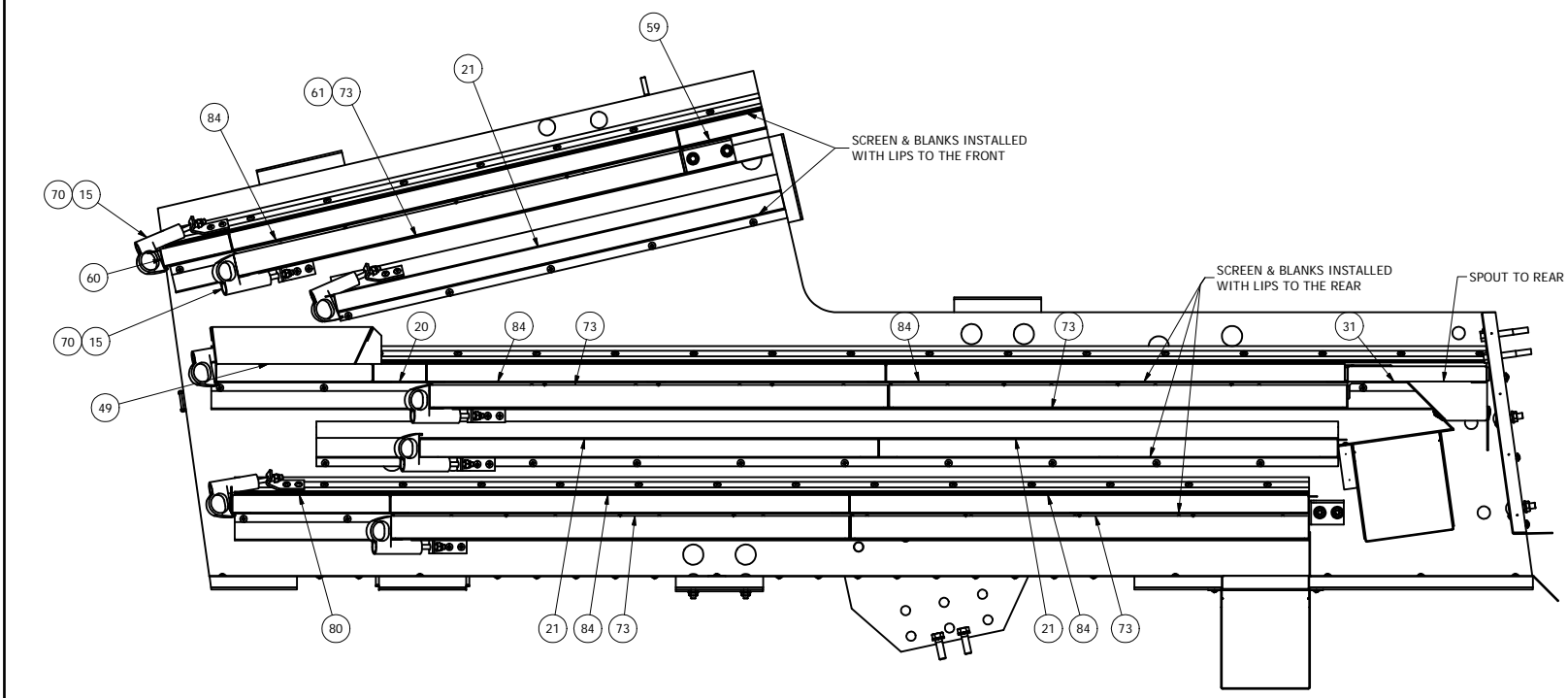

SCREEN INSTALLATION, SPLIT SIFT ARRANGEMENT ONLY, RIGHT SIDE VIEW

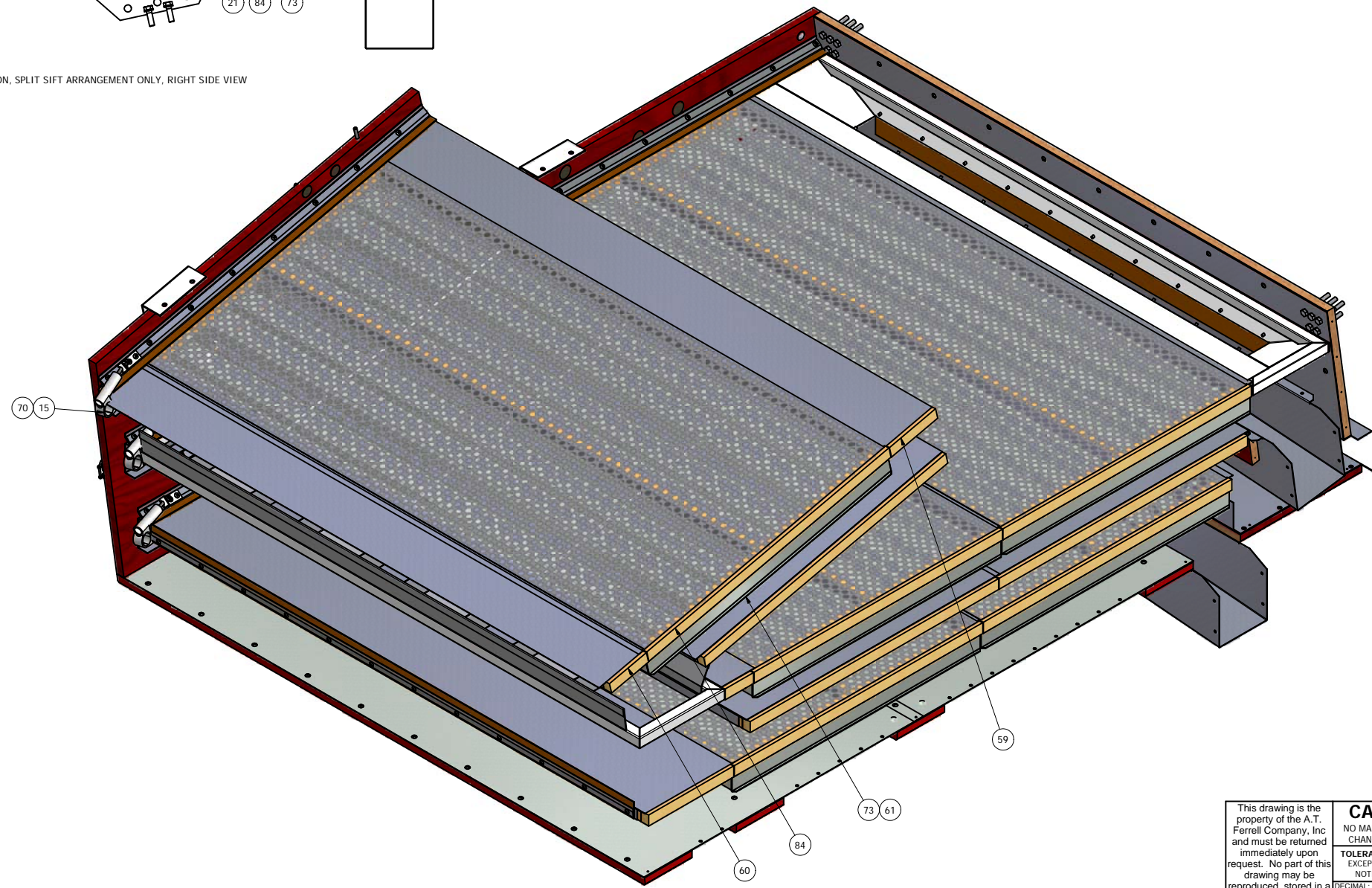

SCREEN INSTALLATION, SPLIT SIFT ARRANGEMENT ONLY

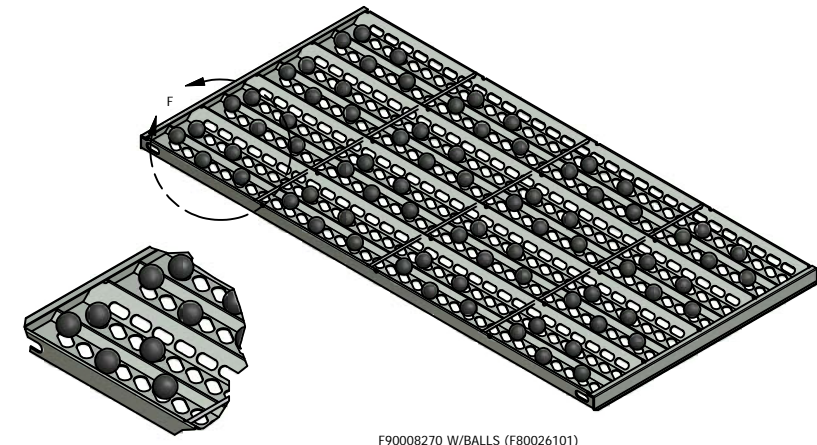

DETAIL F
 SCALE 3/16
 5 BALLS (F80026102) PER COMPARTMENT
 80 BALLS PER TRY

F90008270 W/BALLS (F80026101)

84	SALES ORDER	5	SCREEN ASSY, 26" W/LIP
83	F98600005	2	STRIKE, SCD20650-9XZE
82	F98600005	2	LATCH, SCD 20649 SS
81	F98200006	4	HINGE, TEE 3.00"
80	F92053390	2	SCREEN BLANK ASSY, 9X54" W/LIP
79	F91152006	1	BELTING, 1-PLY .06X2.50X51.00"
78	F91152004	2	BELTING, 3-PLY FSXFS 1.50 X 75.00"
77	F91152004	2	BELTING, 3-PLY FSXFS 1.50 X 63.50"
76	F91152004	2	BELTING, 3-PLY FSXFS 1.50 X 37.06"
75	F91152004	1	BELTING, 1-PLY .06X1.50X51.00"
74	F91151004	1	BELTING, 1-PLY .06 X 4.00 X 51.00"
73	F90008270	5	BALL TRAY WLDMT, 26.25 X 54.00" NG
72	F90005474	2	SCREEN STOP WLDMT, RH NG
71	F90005473	2	SCREEN STOP WLDMT, LH NG
70	F83453402	469	SMS, PHP PAN HD #8 X 3/4"
69	F83440301	38	SMS, FLAT CROSS HEAD #10 X 1.50"
68	F83440135	16	SCW, SMS PAN HD #10 X 1.75"
67	F83200011	23	RIVET, POP SDS64 .188X.125-.250
66	F82631032	12	NUT, KEPS 10-32
65	F82400002	28	NAIL, 14 GA X 3/4" THRD, 7/32" HD T304SS
64	F82071401	2	STUD, DOWEL 1/4-20 X 2.50"
63	F82025603	38	BOLT, ELEV 5/16-18 X 1.50"
62	F82021407	4	BOLT, ELEV 1/4-20 X 1.25"
61	F80026101	240	BALL, RUBBER 1.375 DIA BLACK
60	F62241426	1	BLANK, SCREEN 4.00 X 54.00" W/LIP
59	F62241425	1	SCREEN BLANK ASSY, 5X54" W/LIP
58	F61261328	1	DEFLECTOR, SHOE 4.00"X45
57	F61261325	1	SHOE BOTTOM METAL II, PRELUDE
56	F61261324	1	DEFLECTOR, FRONT, PRELUDE SHOE
55	F61261322	1	SHOE BOTTOM METAL I, PRELUDE
54	F61261321	1	DOOR, PRELUDE SHOE
53	F61261320	2	SIDE, SHOE PRELUDE
52	F61001258	3	SPOUT, DISCHARGE 5 DEG, CONQUEST
51	F61001251	1	PLUG, SPOUT, SHOE SIDE, CONQUEST
50	F61001248	2	BRACKET, SCALP SPOUT, CONQUEST
49	F61001216	1	SPLITTER WLDMT, 50/50 HI-CAP, 9.00" X #8
48	F61001214	1	DEFLECTOR, SPOUT, CONQUEST
47	F61001212	8	BRACKET, CROSS BOARD 5.00"
46	F61001210	2	HANGER SUPPORT, CONQUEST
45	F61001209	2	BOARD, CROSS 7 DEG 5.00 X 55.75"
44	F61001208	5	BOARD, CROSS 5.00 X 55.75"
43	F61001206	2	SCREENWAY RAIL III, 73.00"
42	F61001206	2	SCREENWAY RAIL III, 61.50"
41	F61001206	2	SCREENWAY RAIL III, 58.50"
40	F61001206	2	SCREENWAY RAIL III, 35.06"
39	F61001206	2	SCREENWAY RAIL III, 26.25"
38	F61001205	2	SCREENWAY RAIL II, 58.50"
37	F61001205	2	SCREENWAY RAIL II, 26.25"
36	F61001204	2	SCREENWAY RAIL I, 73.00"
35	F61001204	2	SCREENWAY RAIL I, 61.50"
34	F61001204	2	SCREENWAY RAIL I, 35.06"
33	F61001203	2	PLATE, PITMAN, CONQUEST
32	F61001200	1	PITMAN WLDMT, 55.75"
31	F61001116	1	DIVERTER ASSY, 8.00X54.00", BTM SHOE, CNQST
30	F61001112	2	END IRON, BOTTOM SHOE, CONQUEST
29	F61001111	1	COVER, SPOUT HOLE, BTM SHOE, CONQUEST
28	F61001110	1	BACK MTL, BTM SHOE, CONQUEST 1360
27	F61001109	1	MTL III, BTM, BTM SHOE, CONQUEST 1360
26	F61001106	2	SPACER, HANGER, BTM SHOE, CONQUEST
25	F61001104	1	BOARD, BACK, BOTTOM SHOE, CONQUEST 1360
24	F61001103	2	BOARD, CROSS 12.81 X 55.75"
23	F61001102	1	BOARD, CROSS INTERNAL 2.50 X 54.25"
22	F61001008	2	SUPPORT, SPOUT, CONQUEST
21	F10808000	3	BLANK ASSY, SCREEN W/LIP 26.25 X 54.00"
20	F10516200	1	SCREEN BLANK, 3X54" W/LIP
19	F03805600	3	RUBBER HOLD-DOWN STRIP, 51.00"
18	F03805600	2	RUBBER HOLD-DOWN STRIP 73.00"
17	F03805600	2	RUBBER HOLD-DOWN STRIP 61.50"
16	F03805600	2	RUBBER HOLD-DOWN STRIP 35.06"
15	F03500800	16	SCREEN HOOK ASSY, STANDARD
14	F03401702	1	APRON ASSY, 1.25 X 55.75"
13	80016019	16	BOLT, ELEV 1/2-13 X 2.00"
12	70010521	30	SCW, DECK FLT HD #6 X 2.00"
11	66785200	16	NUT, 1/2-13 HEX SERRATED
10	66783800	52	NUT, HEX SERR LOCK 5/16-18
9	66783300	26	NUT, HEX SERR LOCK 1/4-20
8	66445200	12	WASHER, LOCK HELICAL 1/2"
7	66444400	8	WASHER, LOCK HELICAL 3/8"
6	62585226	12	HHCS, 1/2-13 X 1.25"
5	62584426	8	HHCS, 3/8-16 X 1.25"
4	62583837	10	HHCS, 5/16-18 X 2.50"
3	62282712	12	SCW, MACH 10-32 X 1/2" PAN CROSS HEAD
2	60283828	14	BOLT, CARR 5/16-18 X 1.50"
1	60283326	20	BOLT, CARR 1/4-20 X 1.25"

This drawing is the property of the A.T. Ferrell Company, Inc and must be returned immediately upon request. No part of this drawing may be reproduced, stored in a retrieval system or transmitted in any form or by any means, without prior written consent of the A.T. Ferrell Company, Inc	CAD NO MANUAL CHANGES	DIVISION OF A. T. FERRELL COMPANY		BLUFFTON, INDIANA - USA		
	TOLERANCES EXCEPT AS NOTED DECIMAL: .005 .010 .020 FRACTIONAL: 1/32 ANGULAR: 1/2°	FINISH: NONE SCALE: 1:8 DRAWN BY: SAH APPROVED BY: DJ			TITLE: ASSY, PRELUDE SHOE	
	DATE: 2/15/2010 SIZE: D PART NUMBER: F61261311	SHEET: 7 of 8				
	SHEET: 7 of 8					

REVISION HISTORY				
REV	ECN	DESCRIPTION	DATE	APPROVED
A	F100036	REDRAWN IN INVENTOR, UPDATED ASSY	2/22/2010	SH

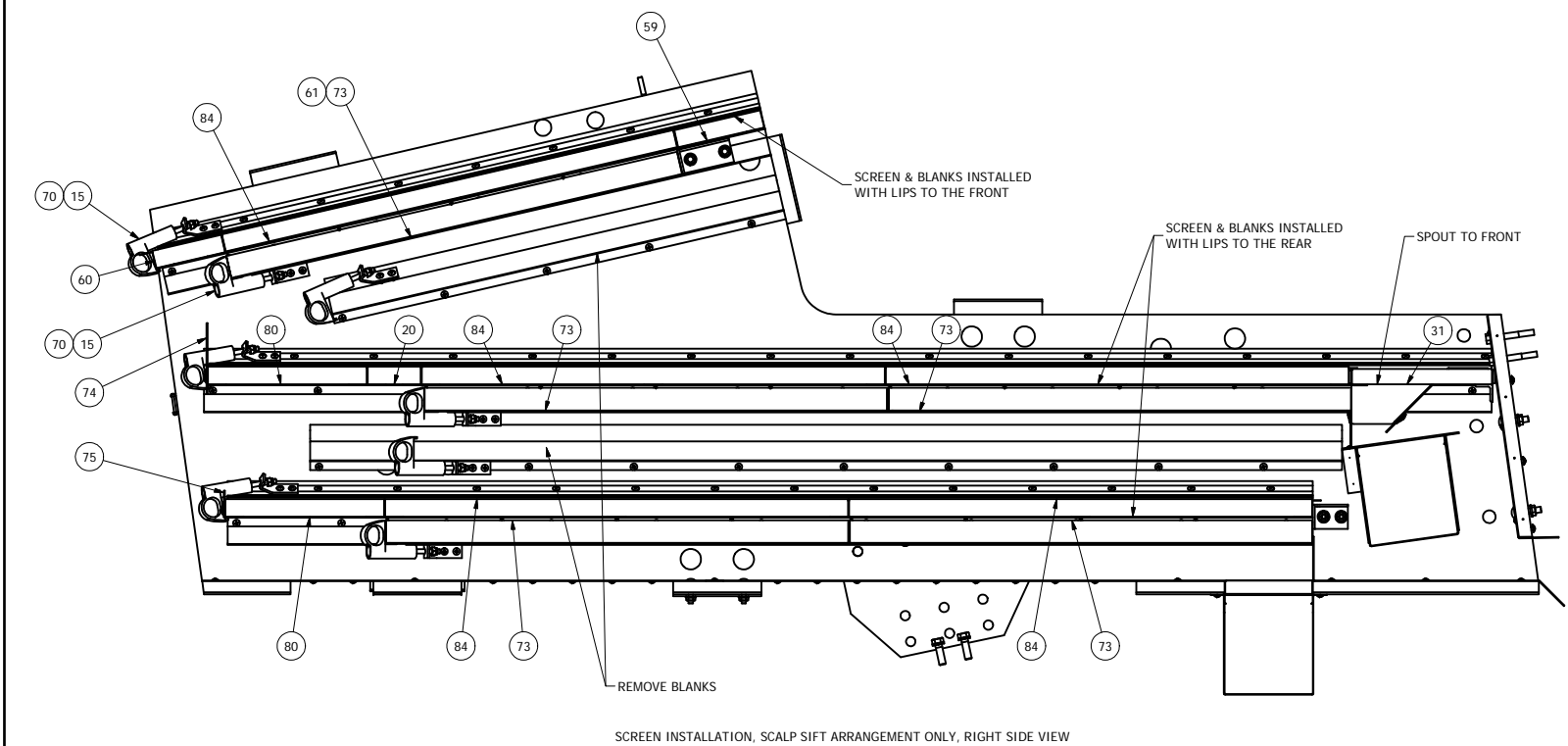

SCREEN INSTALLATION, SCALP SIFT ARRANGEMENT ONLY, RIGHT SIDE VIEW

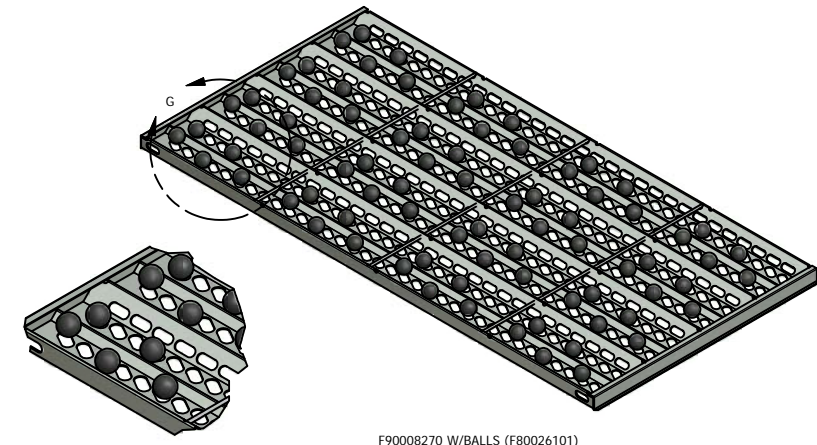

DETAIL G
 SCALE 3/16
 5 BALLS (F80026102) PER COMPARTMENT
 80 BALLS PER TRY

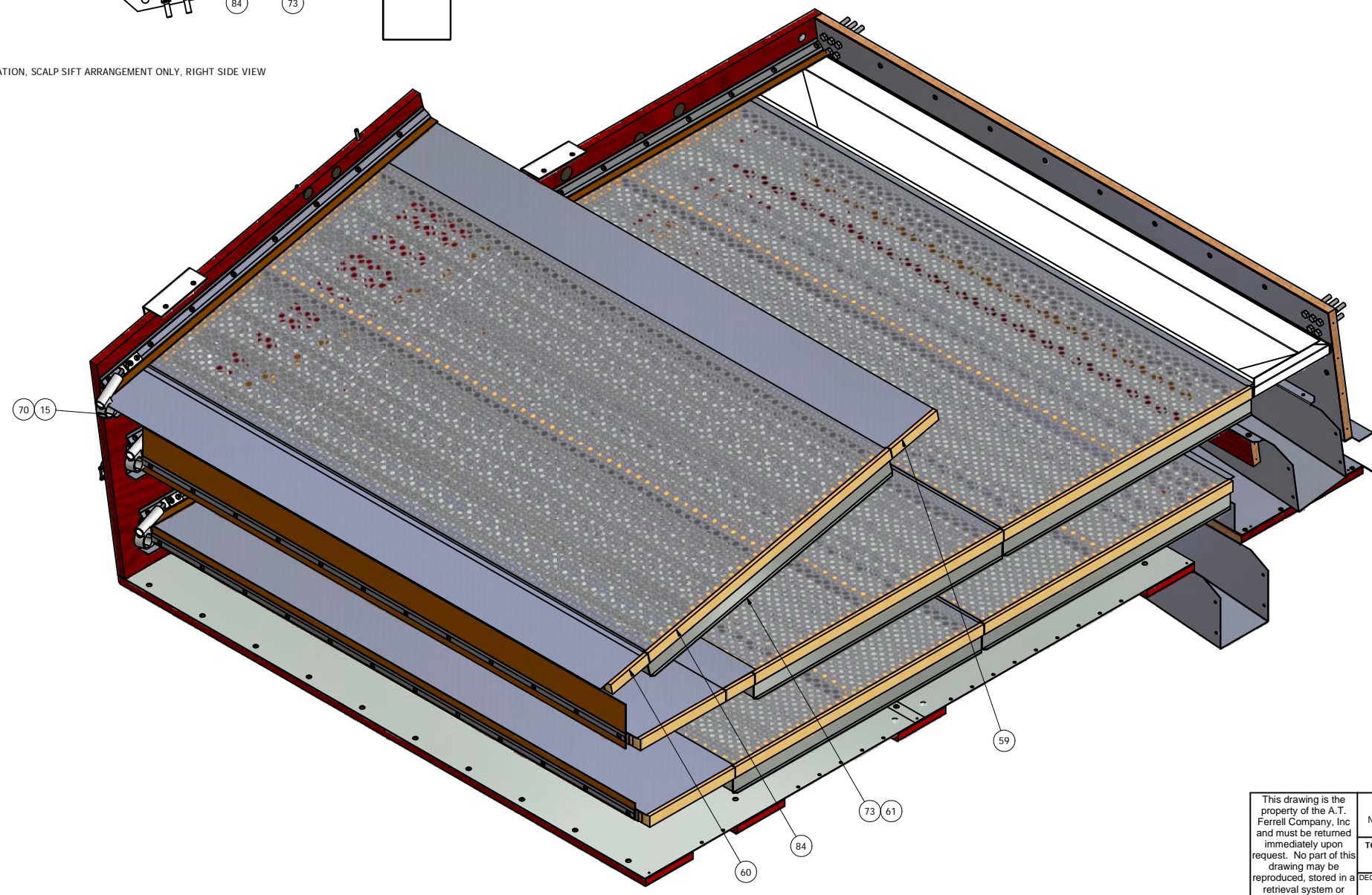

SCREEN INSTALLATION, SCALP SIFT ARRANGEMENT ONLY

84	SALES ORDER	5	SCREEN ASSY, 26" W/LIP
83	F98600005	2	STRIKE, SCD20650-9XZE
82	F98600005	2	LATCH, SCD 20649 SS
81	F98200006	4	HINGE, TEE 3.00"
80	F92053390	2	SCREEN BLANK ASSY, 9X54" W/LIP
79	F91152006	1	BELTING, 1-PLY .06X2.50X51.00"
78	F91152004	2	BELTING, 3-PLY FSXFS 1.50 X 75.00"
77	F91152004	2	BELTING, 3-PLY FSXFS 1.50 X 63.50"
76	F91152004	2	BELTING, 3-PLY FSXFS 1.50 X 37.06"
75	F91152004	1	BELTING, 1-PLY .06X1.50X51.00"
74	F91151004	1	BELTING, 1-PLY .06 X 4.00 X 51.00"
73	F90008270	5	BALL TRAY W/LIP, 26.25 X 54.00" NG
72	F90005474	2	SCREEN STOP W/LIP, RH NG
71	F90005473	2	SCREEN STOP W/LIP, LH NG
70	F83453402	469	SMS, PHP PAN HD #8 X 3/4"
69	F83440301	38	SMS, FLAT CROSS HEAD #10 X 1.50"
68	F83440135	16	SCW, SMS PAN HD #10 X 1.75"
67	F83200011	23	RIVET, POP SDS64 .188X.125-.250
66	F82631032	12	NUT, KEPS 10-32
65	F82400002	28	NAIL, 14 GA X 3/4" THRD, 7/32" HD T304SS
64	F82071401	2	STUD, DOWEL 1/4-20 X 2.50"
63	F82025603	38	BOLT, ELEV 5/16-18 X 1.50"
62	F82021407	4	BOLT, ELEV 1/4-20 X 1.25"
61	F80026101	240	BALL, RUBBER 1.375 DIA BLACK
60	F62241426	1	BLANK, SCREEN 4.00 X 54.00" W/LIP
59	F62241425	1	SCREEN BLANK ASSY, 5X54" W/LIP
58	F61261328	1	DEFLECTOR, SHOE 4.00"X45
57	F61261325	1	SHOE BOTTOM METAL II, PRELUDE
56	F61261324	1	DEFLECTOR, FRONT, PRELUDE SHOE
55	F61261322	1	SHOE BOTTOM METAL I, PRELUDE
54	F61261321	1	DOOR, PRELUDE SHOE
53	F61261320	2	SIDE, SHOE PRELUDE
52	F61001258	3	SPOUT, DISCHARGE 5 DEG, CONQUEST
51	F61001251	1	PLUG, SPOUT, SHOE SIDE, CONQUEST
50	F61001248	2	BRACKET, SCALP SPOUT, CONQUEST
49	F61001216	1	SPLITTER W/LIP, 50/50 HI-CAP, 9.00" X #8
48	F61001214	1	DEFLECTOR, SPOUT, CONQUEST
47	F61001212	8	BRACKET, CROSS BOARD 5.00"
46	F61001210	2	HANGER SUPPORT, CONQUEST
45	F61001209	2	BOARD, CROSS 7 DEG 5.00 X 55.75"
44	F61001208	5	BOARD, CROSS 5.00 X 55.75"
43	F61001206	2	SCREENWAY RAIL III, 73.00"
42	F61001206	2	SCREENWAY RAIL III, 61.50"
41	F61001206	2	SCREENWAY RAIL III, 58.50"
40	F61001206	2	SCREENWAY RAIL III, 35.06"
39	F61001206	2	SCREENWAY RAIL III, 26.25"
38	F61001205	2	SCREENWAY RAIL II, 58.50"
37	F61001205	2	SCREENWAY RAIL II, 26.25"
36	F61001204	2	SCREENWAY RAIL I, 73.00"
35	F61001204	2	SCREENWAY RAIL I, 61.50"
34	F61001204	2	SCREENWAY RAIL I, 35.06"
33	F61001203	2	PLATE, PITMAN, CONQUEST
32	F61001200	1	PITMAN W/LIP, 55.75"
31	F61001116	1	DIVERTER ASSY, 8.00X54.00", BTM SHOE, CNQST
30	F61001112	2	END IRON, BOTTOM SHOE, CONQUEST
29	F61001111	1	COVER, SPOUT HOLE, BTM SHOE, CONQUEST
28	F61001110	1	BACK MTL, BTM SHOE, CONQUEST 1360
27	F61001109	1	MTL III, BTM, BTM SHOE, CONQUEST 1360
26	F61001106	2	SPACER, HANGER, BTM SHOE, CONQUEST
25	F61001104	1	BOARD, BACK, BOTTOM SHOE, CONQUEST 1360
24	F61001103	2	BOARD, CROSS 12.81 X 55.75"
23	F61001102	1	BOARD, CROSS INTERNAL 2.50 X 54.25"
22	F61001008	2	SUPPORT, SPOUT, CONQUEST
21	F10808000	3	BLANK ASSY, SCREEN W/LIP 26.25 X 54.00"
20	F10516200	1	SCREEN BLANK, 3X54" W/LIP
19	F03805600	3	RUBBER HOLD-DOWN STRIP, 51.00"
18	F03805600	2	RUBBER HOLD-DOWN STRIP 73.00"
17	F03805600	2	RUBBER HOLD-DOWN STRIP 61.50"
16	F03805600	2	RUBBER HOLD-DOWN STRIP 35.06"
15	F03500800	16	SCREEN HOOK ASSY, STANDARD
14	F03401702	1	APRON ASSY, 1.25 X 55.75"
13	80016019	16	BOLT, ELEV 1/2-13 X 2.00"
12	70010521	30	SCW, DECK FLT HD #6 X 2.00"
11	66785200	16	NUT, 1/2-13 HEX SERRATED
10	66783800	52	NUT, HEX SERR LOCK 5/16-18
9	66783300	26	NUT, HEX SERR LOCK 1/4-20
8	66445200	12	WASHER, LOCK HELICAL 1/2"
7	66444400	8	WASHER, LOCK HELICAL 3/8"
6	62585226	12	HHCS, 1/2-13 X 1.25"
5	62584426	8	HHCS, 3/8-16 X 1.25"
4	62583837	10	HHCS, 5/16-18 X 2.50"
3	62282712	12	SCW, MACH 10-32 X 1/2" PAN CROSS HEAD
2	60283828	14	BOLT, CARR 5/16-18 X 1.50"
1	60283326	20	BOLT, CARR 1/4-20 X 1.25"

ITEM	PART NUMBER	QTY	DESCRIPTION													
<table border="0"> <tr> <td rowspan="2"> This drawing is the property of the A.T. Ferrell Company, Inc and must be returned immediately upon request. No part of this drawing may be reproduced, stored in a retrieval system or transmitted in any form or by any means, without prior written consent of the A.T. Ferrell Company, Inc </td> <td> CAD NO MANUAL CHANGES </td> <td colspan="2"> </td> </tr> <tr> <td> TOLERANCES EXCEPT AS NOTED DECIMAL: .005 XX ± .030 FRACTIONAL: 1/32 ANGULAR: ± 1/2° </td> <td> FINISH: NONE SCALE: 1:8 DRAWN BY: SAH APPROVED BY: DJ </td> <td colspan="2"> DIVISION OF A. T. FERRELL COMPANY BLUFFTON, INDIANA - USA </td> </tr> <tr> <td colspan="2"> TITLE: ASSY, PRELUDE SHOE </td> <td> DATE: 2/15/2010 </td> <td> SIZE: D PART NUMBER: F61261311 </td> <td> SHEET: 8 of 8 </td> </tr> </table>				This drawing is the property of the A.T. Ferrell Company, Inc and must be returned immediately upon request. No part of this drawing may be reproduced, stored in a retrieval system or transmitted in any form or by any means, without prior written consent of the A.T. Ferrell Company, Inc	CAD NO MANUAL CHANGES			TOLERANCES EXCEPT AS NOTED DECIMAL: .005 XX ± .030 FRACTIONAL: 1/32 ANGULAR: ± 1/2°	FINISH: NONE SCALE: 1:8 DRAWN BY: SAH APPROVED BY: DJ	DIVISION OF A. T. FERRELL COMPANY BLUFFTON, INDIANA - USA		TITLE: ASSY, PRELUDE SHOE		DATE: 2/15/2010	SIZE: D PART NUMBER: F61261311	SHEET: 8 of 8
This drawing is the property of the A.T. Ferrell Company, Inc and must be returned immediately upon request. No part of this drawing may be reproduced, stored in a retrieval system or transmitted in any form or by any means, without prior written consent of the A.T. Ferrell Company, Inc	CAD NO MANUAL CHANGES															
	TOLERANCES EXCEPT AS NOTED DECIMAL: .005 XX ± .030 FRACTIONAL: 1/32 ANGULAR: ± 1/2°	FINISH: NONE SCALE: 1:8 DRAWN BY: SAH APPROVED BY: DJ	DIVISION OF A. T. FERRELL COMPANY BLUFFTON, INDIANA - USA													
TITLE: ASSY, PRELUDE SHOE		DATE: 2/15/2010	SIZE: D PART NUMBER: F61261311	SHEET: 8 of 8												